

Operating Manual

GEDA[®]
ERA 1200 Z/ZP

Construction Hoist / Transport Platform
For persons and loads



Mertinger Strasse 60 • D-86663 Asbach-Bäumenheim

Telephone + 49 906 9809- 0

Telefax + 49 906 9809-50

Email: info@geda.de

WWW: <http://www.geda.de>

EC Declaration of Conformity



The manufacturer

GEDA-Dechentreiter GmbH & Co. KG
 Mertinger Str. 60
 DE-86663 Asbach-Bäumenheim

hereby declares that the machine

Designation: **Building hoist / Transport platform**
 (or temporary, non-public use by authorised persons)

Type: **GEDA® ERA 1200 Z/ZP**

Year of manufacture: see type plate of the machine

Serial No.: E120257 / E120258 / E120259

is in compliance with all pertinent provisions of the following directives at the time of being put on the market.

<u>Directives:</u>	<u>Applied conformity evaluation procedure:</u>
2006/42/EC Machinery Directive	Appendix VIII
2006/95/EC Low Voltage Directive	Appendix IV
2004/108/EC EMC Directive	Appendix II
2000/14/EC Noise Emissions Directive	Appendix V

Applied (harmonised) norms:

EN ISO 12100:2010
 EN 60204-1/32

EC type testing procedure:	
Type testing certification	EG-MRL 033/1
European notified body	0036 TÜV SÜD Industrie Service GmbH Westendstraße 199 80686 München

This EC conformity declaration becomes null and void if any changes are made to the aforementioned machine that have not been authorised by the manufacturer.

Authorised representative for technical documentation is the signatory.

Asbach-Bäumenheim 2011-01-03

Johann Sailer
 (Managing Director
 GEDA-Dechentreiter GmbH & Co. KG)

Table of Contents:

Chapter	Page
1 General information	5
1.1 Information about the instruction manual	5
1.2 Abbreviations	7
1.3 Information about the machine	7
1.4 Name and address of the manufacturer	8
1.5 Notes about the author and industrial property rights	8
1.6 Instructions for the operating company	9
1.7 Intended use	10
1.7.1 Requirements of assembly personnel	11
1.7.2 Operating personnel	11
1.7.3 Improper use	11
2 General safety information	12
2.1 Residual risks	12
2.2 Safety instructions for operating personnel	13
2.3 Safety instructions for transport	14
2.4 Safety instructions for operation	15
2.5 Safety instructions for servicing, maintenance and troubleshooting	16
2.6 Safety whilst working on the electrics	18
3 Technical description	19
3.1 Description of function	19
3.1.1 Use as a material hoist	20
3.1.2 Use as a transport platform / climbing platform	20
3.2 Machine equipment	21
3.2.1 Ground station switch box	23
3.2.2 Switch cabinet with platform control	23
3.2.3 Ground control (manual control)	24
3.2.4 Drop-test control	24
3.2.5 Platform access, ground station	25
3.2.6 Platform access, building	25
3.2.7 Document box	26
3.3 Equipment as accessories	27
3.3.1 Assembly bridge	27
3.3.2 Auxiliary assembly bridge for platform extension (only for platform "C") ..	27
3.3.3 Electric module for landing level equipment	28
3.3.4 Roof	28
3.3.5 Underride protection	28
3.3.6 Ground base enclosure with barriers	29
3.3.7 Front platform access points	29
3.3.8 Mast assembly aid	30
3.3.9 Central spindle	30
3.3.10 Cold package	31
3.3.11 Operating time indicator	31

Chapter	Page
3.4	Technical Data..... 32
3.4.1	Operating and environmental conditions 32
3.4.2	Speeds 33
3.4.3	Electrical connected loads..... 33
3.4.4	Assembly height 33
3.4.5	Emissions 33
3.4.6	Mast 34
3.4.7	Load capacity, Dimensions and weights 35
4	Operation..... 37
4.1	Safety during operation 37
4.1.1	Special safety instructions for operation as a material hoist..... 38
4.1.2	Special safety instructions for operation as a transport platform 38
4.1.3	Safety check before starting work 39
4.2	Operation of the platform access points and the landing-level safety doors... 40
4.2.1	Base enclosure barrier (option) 40
4.2.2	Loading door / Ramp..... 41
4.2.3	Barrier with loading door..... 42
4.2.4	Landing door 42
4.3	Operating as a material hoist..... 43
4.4	Operating as transport platform 45
4.5	Emergency shutdown 47
4.6	Interrupting work – end of work 47
5	Malfunctions - Diagnosis – Repair 48
5.1	Diagnostic system (option) 49
5.2	Fault table..... 50
5.3	Fault rectification 51
5.3.1	Motor is not producing full output 51
5.3.2	Platform moved too high..... 51
5.3.3	Platform has run too low..... 52
5.3.4	Overload warning device has triggered 53
5.3.5	Safety gear has triggered 53
5.4	Retrieving the platform 56
5.4.1	Basic conduct in the event of a rescue/malfunction..... 56
5.4.2	Rescue action plan..... 57
5.5	Repair..... 59
6	Disposal of the machine 60

1 General information

1.1 *Information about the instruction manual*

This operating manual is an essential aid to operating the machine **successfully and hazard-free**.

This operating manual contains important instructions on how to operate the machine **safely, correctly and efficiently**. Compliance with these instructions helps to avoid hazards and increases the reliability and service life of the machine.

The operating manual must be **available at the machine at all times** and must be read and applied by every person commissioned to work on/with the machine, e.g.:

- Operating, fault rectification during work, disposal of operating materials and auxiliary supplies,
- assembly, maintenance (servicing, general maintenance, repairs) and/or transport.

You will come across a series of illustrations and symbols while reading this manual which are intended to help you navigate through and understand this manual. The different meanings are explained below.

Text display	Meaning
Bold type	Emphasises particularly important words/passages
• List 1	Denotes lists
- List 2	Denotes lists
(brackets)	Item numbers
➤ Instruction	Instruction to personnel Always given in chronological order

Images



The illustrations used refer to a specific machine type. They may only constitute a schematic representation with other machine types. The fundamental function and operation is not affected by this.

The **structural elements** in this operating manual appear as follows and have the following meaning:



Health and safety symbol

This symbol is found next to all safety instructions where there is a risk of injury or a fatality. Observe these instructions and be very cautious!

Warning level	Consequence	Probability
 DANGER	Death / serious injury	is imminent
 WARNING	serious injury	possible
 CAUTION	minor injury	possible
CAUTION	tangible damage	possible



Attention note

This is found at points where special information or instructions and restrictions regarding damage prevention are given in order to prevent damage to the equipment.



Note

This is found at points where information is given about using the machine economically or instructions are given regarding correct working procedures.

1.2 **Abbreviations**

The following abbreviations may be used in the manual.

max.	maximum	Nm	Newton metre
min.	minimum	km/h	kilometres per hour
mins.	minutes	mph	miles per hour
etc.	et cetera	inc.	including
poss.	possible/possibly	if nec.	if necessary
e.g	for example	i.e.	id est (that is)
ml	millilitre	reg.	regarding
mm	millimetre	RH	relative humidity
°C	degrees Celsius	approx.	approximately
°F	degrees Fahrenheit	∅	diameter
ft.	feet	®	registered trademark
ft/m	feet per minute	©	copyright
m/min	metres per minute	TM	trademark
in.	inch	%	per cent
etc.	et cetera	‰	per thousand
lbs.	pounds	dB (A)	sound pressure level
lbf.-ft	pounds per feet	LWA	sound power level
kg	kilogram	>	greater than
l	litre	<	less than
gal.	gallons	±	plus or minus
kip	kilopound		

1.3 **Information about the machine**

Machine model	GEDA ERA 1200 Z/ZP
Year of manufacture:	Refer to nameplate
Works number:	E120257, E120258, E120259
Documentation version:	10/2013

1.4 **Name and address of the manufacturer**

GEDA Dechentreiter GmbH & Co. KG
 Mertinger Strasse 60
 86663 Asbach-Bäumenheim
 Tel.: +49 9 06 9809-0
 Fax: +49 9 06 9809-50
 E-Mail: info@geda.de
 Web: www.geda.de

Representatives of the manufacturer

Bergkamen Subsidiary	Gera Subsidiary
GEDA Dechentreiter GmbH & Co. KG Northwest branch Marie-Curie-Strasse 11 59192 Bergkamen-Rünthe Tel. +49 2389 9874-32 Fax. +49 2389 9874-33	GEDA Dechentreiter GmbH & Co. KG East branch Ernst-M.-Jahr Strasse 5 07552 Gera Tel. +49 365 55280-0 Fax. +49 365 55280-29
USA Subsidiary	Russia Subsidiary
GEDA USA, LLC P.O. BOX 752086 USA 77275 Houston, Texas Tel. +1(713) 621 7272 Fax. +1(713) 621 7279 Web: www.gedausa.com	GEDA RUS, LLC Yaroslavskoe shosse 42 129337 Moscow Russian Federation Tel. +7(495) 663 24 48 Fax. +7(495) 663 24 49 Web: www.geda-ru.com
Turkey Subsidiary	
GEDA MAJOR IS VE INSAAT MAKINALARI SAN. TIC. LTD . STI. Semsettin Günaltay Cad. No:224 A Blok K:2 D:5 Tüccarbasi/Erenköy TR-34734 Istanbul/Turkey Tel.: +90 (216) 478 2108 Fax: +90 (216) 467 3564 Web: www.geda.com.tr	

1.5 **Notes about the author and industrial property rights**

All documents are protected in terms of copyright law. Dissemination and reproduction of documents (even parts thereof), as well as recycling or communication of their contents are prohibited unless expressly permitted in writing.

Violations are an offence and incur an obligation to pay compensation. All rights to exercise industrial property rights are reserved by **GEDA**.

1.6 **Instructions for the operating company**

This operating manual is an essential component of the machine. The operating company must ensure that operating personnel are **informed** about these guidelines.

The operating company must supplement the operating manual with **operating instructions** based on existing **national regulations for accident prevention** and for the **protection of the environment**, including information regarding supervisory and reporting duties that take account of company-related specifics, e.g. with reference to work organisation, work procedures and the personnel employed.

In addition to the obligatory **regulations for accident prevention and industrial safety** that apply both in the country of use and at the place of use, accepted professional rules for working safely and competently must also be observed.

The operating company must make sure that operating personnel wear **personal protective gear** as appropriate to the local conditions.

First aid facilities (first aid kit, etc.) must be kept within reach!

The operating company/user of the machine **must not make any changes, additions or modifications** to the machine that could impair safety without permission from the manufacturer! This also applies to installing and adjusting safety equipment, as well as welding onto load-bearing components.

Any **replacement and wear parts** that are used must correspond to the technical requirements stipulated by **GEDA**. This is ensured with **original replacement parts**.

Only employ **qualified and/or trained personnel** for the tasks described in this manual.

The operating company clearly defines the responsibilities of the personnel for operation/assembly/maintenance.

The operating company is obliged to train all persons authorised to use the machine in the correct handling of the machine before using it for the first time, according to the respective area of activity and responsibility of the authorised individual and using practical exercises. This **training** must be documented and **repeated at regular intervals**. The legally permissible minimum age must be observed!

1.7 **Intended use**

The **GEDA ERA 1200 Z/ZP** is a construction material hoist as well as a transport platform that is temporarily erected and

- which may only be operated after the landing level safety doors are installed at each transfer point to the building or scaffolding.
- which may only be operated at wind speeds of up to 72 km/s (20 m/sec. ≈ wind force 7-8 according to the Beaufort scale).
- which must have its platform parked on the ground and taken out of operation at higher wind speeds.

as construction material hoist

- which is intended exclusively for putting up scaffolding and for transporting items and materials during construction work.
- which may only be operated from outside the cordoned-off and signposted hazard area using the ground control and/or operated from the electric modules on the landing level control above the 2 m safety height.

as transport platform and carrying persons

- Determined for the transport of material and a max. of 7 persons who can exit the platform at installed and secured exit points.
- It must only be used by trained personnel (platform operator) on construction sites.
- The equipment can only be operated from the platform in dead man's control.
(Operation is not possible from other control locations.)
- There is the option to stop at any position (e.g. to unload bulky components over the base enclosure).

As a mast climbing platform

- Determined for the transport of material and a max. of 7 persons who can carry out tasks from the platform.
- The equipment can only be operated from the platform in dead man's control.
(Operation is not possible from other control locations.)

Observe and comply with the instructions in Chapter 3.4, "Technical specifications".

Any other use or any use going beyond this is not considered proper use.

The operating company/user of the machine is solely liable for any damage resulting from such action. This applies equally to any arbitrary changes to the machine.

Intended use includes:

- That the assembly, operation and maintenance provisions (assembly and operating manual) provided by the manufacturer are complied with.
- That the foreseeable misconduct of other persons is taken into consideration.
- That the corresponding national regulations are complied with.



The GEDA ERA 1200 Z/ZP is suitable for temporary use on construction sites. Any other locations or intended uses require written approval from the manufacturer.

1.7.1 Requirements of assembly personnel

The machine must only be assembled, operated and maintained by competent persons who, based on their training, knowledge and practical experience, can ensure correct handling of the machine and who are aware of the risks associated with the transport platform. These persons must be appointed to the tasks of installation, dismantling and maintenance by the operating company.

1.7.2 Operating personnel

The machine may be operated only by persons who, based on their training, knowledge and practical experience, can guarantee proper handling.

These persons must

- have been appointed by the operating company,
- have been appropriately instructed and informed about the risks,
- be familiar with the assembly and operating manual,
- observe national regulations.

1.7.3 Improper use

- The **GEDA ERA 1200 Z/ZP** is not designed for permanent installation.
- The **GEDA ERA 1200 Z/ZP** must not be assembled to be free-standing (without anchors).
- Persons who have not been instructed about the machine and who are not acquainted with the operating manual, or children, may not operate the **GEDA ERA 1200 Z/ZP**.

Consequences of improper use of equipment

- Danger to life and limb of the user or a third party.
- Damage to the machine and other tangible assets.

2 General safety information

The machine has been designed and built according to the latest standards of technology and recognised safety-related rules.

Nevertheless, hazards for personnel or third parties and/or damage to machinery and other tangible assets can occur during use, e.g. if the machine:

- Is operated by untrained or uninstructed personnel,
- Is used improperly,
- Is assembled, operated and serviced inappropriately.

Attached notices and warning signs must be observed!

Consequences of not complying with safety instructions

Non-compliance with safety instructions can result in danger both for personnel as well as for the environment and the machine. Non-compliance can lead to the forfeiture of any damage compensation claims.

2.1 *Residual risks*

There are still residual risks remaining from working with the machinery even when all safety conditions are complied with.

Everyone who works on and with the machine must be aware of these hazards and follow instructions that prevent these residual risks leading to accidents or damage.



Caution

- Do not remove safety stickers; replace any safety instructions that have become illegible.
- Hazards due to toppling of an improperly secured load.
- Hazards due to high wind speeds (> 72 km/h)
- Hazards when accessing and exiting the platform.
- Hazard of damage to the mast sections, anchors or base unit.
- Hazards when working on the electrical system.
- Hazards from a malfunction in the control system.
- Injuries due to uncoordinated work methods.

2.2 **Safety instructions for operating personnel**

The operating manual must be within reach at all times **at the location where the machine is used.**

The machine may only be used in a technically fault-free condition, as well as **in accordance with the intended use, in a safety conscious manner aware of the hazards**, and while observing the operating manual! In particular rectify faults immediately that could impair safety!

In addition to this, the machine may only be operated when all **safety features are present and functioning!**

Check the machine **at least once each working day** for externally identifiable damage and defects! Immediately report any changes (including changes to the operating behaviour) to the office/person in charge. If necessary, shutdown and secure the machine immediately! The **responsibilities** for different jobs within the context of operation, servicing and maintenance of the machine must be clearly stipulated and adhered to. This is the only way to avoid mistakes especially in hazardous situations.

The pertinent **rules for prevention of accidents** as well as the other, generally recognised, safety-related and industrial health related rules must be adhered to.

The operator is obliged to wear **personal protective equipment** as appropriate to the local conditions.

Switch-on and shutdown procedures, including emergency shutdown, must be observed in accordance with the operating manual for all work that affects operation, and for conversions and adjustments to the machine and its safety features.

2.3 ***Safety instructions for transport***

Immediately report **transport damage** and/or **missing parts** to the supplier.

During transport work, wear a **safety helmet, safety shoes** and **safety gloves!**

Never step under suspended loads!

Only use **appropriate, standardised and tested lifting gear**, forklifts, cranes) and sling gear (round slings, lifting straps, sling ropes, chains) for transport at the assembly site.

When selecting hoisting equipment, always take into account the **maximum suspended loads!**

Please refer to the dimensions and weights in the technical specifications chapter (3.4).

Only carefully load and transport equipment that has been **disassembled, packaged and lashed.**

Always ensure that the machine is transported **without being knocked or jolted.**

Observe the **pictograms on the packaging.**

Only attach gear to the **designated sling points.**

Always secure transported loads **against falling or tipping over!**

2.4 **Safety instructions for operation**

Only operate the machine, under consideration of the operating manual, **when it is fully serviceable and in a safety and hazard conscious manner.**

If **work is interrupted**, switch off the machine at the **main switch** and secure it with a padlock against switching on.

Fundamentally, the machine must be **secured against unauthorised use** (disconnect from power)!

In situations that present a **risk to operating personnel** or the machine, shut down the machine by pressing the **EMERGENCY STOP** button.

Shut down and lower the machine when wind speeds are >72 km/h. (Wind force 7-8, wind breaks branches off trees, makes walking very difficult!)

No one is allowed to stand under the machine. Ensure that the danger zone is suitably cordoned off at the customer's site.

Protection to prevent persons from falling must be provided at loading heights above 2.0 m. (Install landing-level safety doors).

Accompanying persons must comply with the **instructions of the platform operator**. Above all, they must not lean out over the sides of the platform or step across material being carried.

2.5 ***Safety instructions for servicing, maintenance and troubleshooting***

Operating personnel must be **informed** about how to carry out special work and maintenance work before they start.

Deadlines that are stipulated or stated in the operating manual for recurring **tests/inspections** must be adhered to.

The **maintenance area** must be **cordoned off** as extensively as required!

Fundamentally, before any maintenance work on the machine

- Unload,
- Switch off at the master switch.

All **servicing and maintenance tasks** are only permitted with the **master switch turned off** or with the **mains plug disconnected**. Manual intervention while the machine is running can lead to serious injury and is therefore prohibited. If it is necessary to **turn the machine on during** such work, then this must only be done while complying with **special safety measures**.



For further instructions about maintenance / maintenance intervals / servicing, refer to the maintenance manual.

If the machine has been completely shut down for these tasks, it must be secured against switching on unintentionally:

- Operate the **emergency STOP** button,
- **Lock the main switch** using a shackle lock **and**
- **Attach a warning notice** to the switch box (main switch).

Any faults that could impair safety must be rectified immediately.

Workshop equipment that is suitable for the specific work is imperative for carrying out **servicing and maintenance tasks**. When carrying out maintenance tasks at greater height, a fall-protection device must be worn! Keep all handles, railings and the platform free from dirt and contamination.

When working under the platform, secure it using appropriate means (e.g. bolts, mast clamps, etc.)

Before starting servicing/repair tasks **clean** the machine, in particular connections and screw connections, from oil, operating fluids, contamination and maintenance products. Abrasive cleaning agents must not be used. **Loosened screw connections** during servicing and maintenance tasks must always be **tightened** using the necessary **torques!**

Do not change, remove, bypass or bridge safety devices. If it is necessary to **remove safety devices** during servicing and repairs, the safety devices must be installed and **checked** immediately after completion of servicing and repair tasks!

Do not make any changes, additions or modifications to the machine. This also applies to the installation and adjustment of safety devices such as limit switches.

Immediately replace damaged or detached notices and warning signs, as well as safety labels.

Ensure that auxiliary supplies, as well as replaced parts, are disposed of safely and in an eco-friendly manner (also refer to Chapter 6)



The aforementioned safety measures apply equally for work in the context of eliminating faults.

2.6 **Safety whilst working on the electrics**

If there are **faults in the electrical system** of the machine, it must be **shut down** immediately using the **master switch** and secured with a lock or the mains plug must be removed!

Work on the electrical equipment of the machine must only be carried out by **qualified electricians** working in accordance to electrical engineering regulations! Only professional electricians may access the machine's electrics and carry out work on it. **Always keep the switch boxes closed** as soon as they are left unattended.

Never work on live parts! System parts on which inspection, maintenance or repair work is to be carried out must be **disconnected from the mains**. Operating fluids that have been disconnected must be secured against being switched back on unintentionally or automatically (lock away fuses, block isolating switches, etc.). The disconnected, electrical components must first be tested to ensure they are voltage-free, then earthed, short-circuited and isolated from neighbouring live components.

If **tasks must be carried out on live components** (only in exceptional circumstances) an **additional person** must be present to operate the **EMERGENCY STOP** button or main switch in the event of an emergency. Only use insulated tools!

During repairs, make sure that **design features** are not **modified** so that they have a negative influence on safety. (e.g. creeping distances, clearances and distances must not be made smaller by insulation.)

Fault-free **earthing** of the electrical system must be ensured by a **protective earth system**.

3 Technical description

3.1 *Description of function*

The **GEDA ERA 1200 Z/ZP** is a rack-and-pinion hoist constructed vertically that, on the one hand, is used as a construction hoist for exclusive use to transport construction material, on the other hand, used as a transport platform for the transport of material and up to a max. of 7 persons. The platform can be entered and exited at secure exit points installed (ground base enclosure and landing-level safety doors). These operating modes are selected using a key switch on the platform control. The base unit can be extended by up to a construction height of 100 m.

- The machine is fitted with an overload device. This switches off the travel movement in both directions when the payload is exceeded and a pulsing warning tone is generated.
- The lifting speed of the hoist is approx. 24 m/min.
- The lowest 2 m are specifically secured.
 - The lifting speed of the hoist is only approx. 12 m/min.
 - Travel is only possible using dead man's control.
 - When the platform is descending and before starting in this range, a signal is sounded for approx. 3 seconds.
 - Within this range, the hoist can only be operated from the landing level control.
- The platform openings (barrier, doors/ramps, assembly guard, assembly frame) are electrically monitored and interrupts the safety circuit on opening so that the platform immediately stops or does not move off.
 - The access at the ground station can only be opened when the platform is actually at the ground station.
- The downward travel path of the platform is limited by a **DOWN** limit switch and the upward travel path is limited by an **UP** limit switch. If there is movement beyond the limit switch, the **EMERGENCY STOP** limit switch interrupts the **EMERGENCY STOP** safety circuit. Further travel from the landing limit switch is not possible in either direction.
- Installation of the hoist includes safety equipment for the loading and unloading points (refer to the assembly instructions).

3.1.1 Use as a material hoist

- Switching to material hoist is carried out at the key switch of the platform control (key removed). The folding plate must be folded down and secured with a lock, so that only control from outside is possible.
- Operation is carried out using the ground control (manual control) outside the danger zone - or from the electric modules of the landing level control when above the 2 m safety height.
- Automatic operation is possible above the 2 m safety height (refer to Ch. 0)

3.1.2 Use as a transport platform / climbing platform

The platform is intended for provisional use on construction sites for transporting persons and materials. It must only be used by trained personnel (platform operator) who receive the key to activate the platform control.

When the cover is folded over the platform control and the key switch on the platform control is switched on by the platform operator, the machine is used as a transport platform or mast climbing platform.

- The maximum number of persons on the platform is limited to 7 (incl. platform operator).
- Operation is only possible from the platform control in dead man's control, thus, other control locations are disabled.
- During descending, the platform stops approx. 2 m above the ground. After the platform operator has made sure that the travel path is clear, he/she presses and holds the **Down** button, then a signal is emitted. After approx. 3 seconds, the platform moves and stops at the **DOWN** limit switch.
- It is possible to stop at any position (e.g. to carry out tasks from the platform or unload bulky components over the enclosure).

3.2 Machine equipment

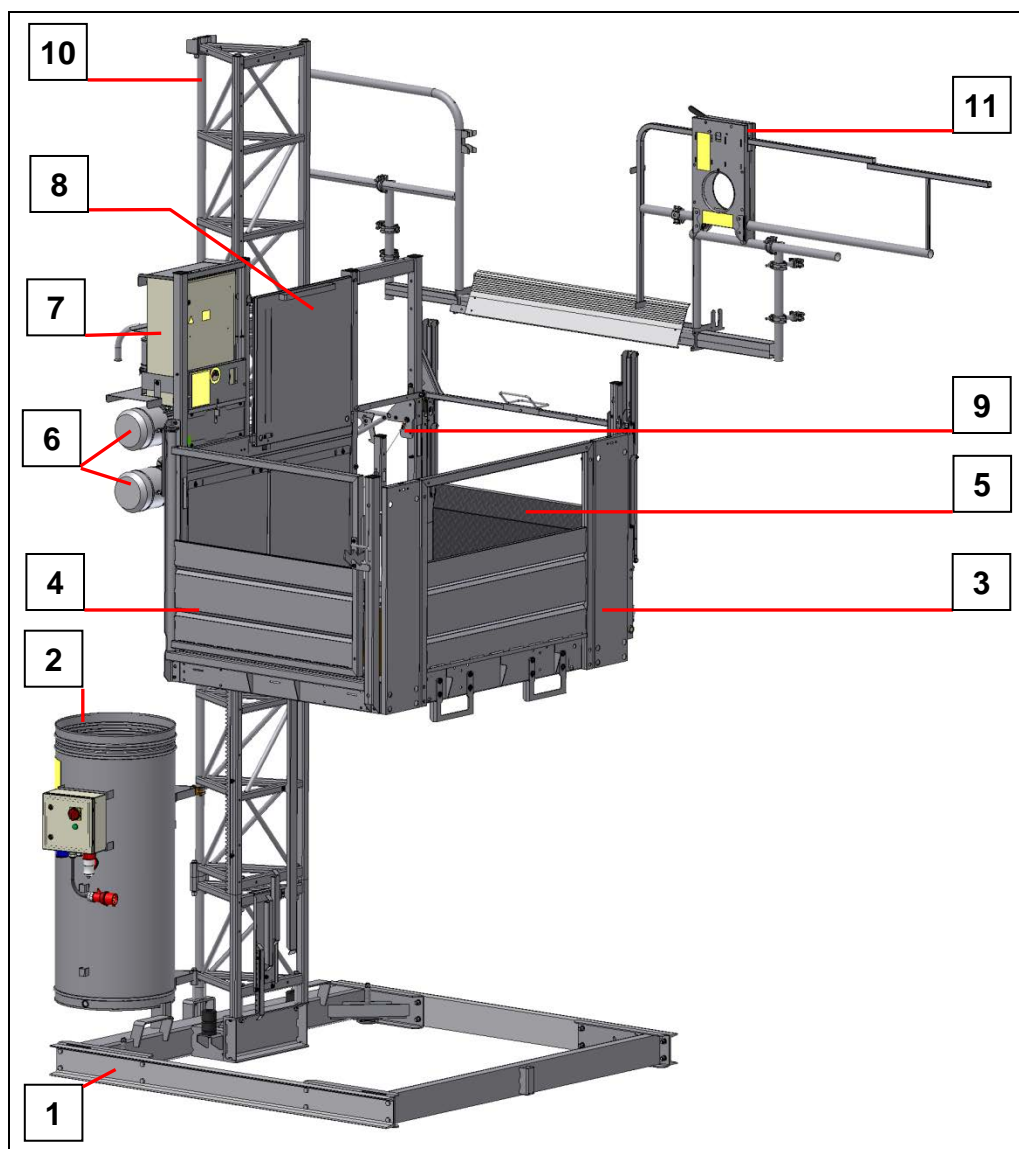

- 1 = Foot section with base mast
- 2 = Cable bin with switch box, ground station
- 3 = Platform
- 4 = Doors (ground station)
- 5 = Barrier with loading door (landing level)
- 6 = Drives
- 7 = Switch box, platform with platform control
- 8 = Assembly guard
- 9 = assembly bridge
- 10 = Mast extension
- 11 = Landing-level safety door

- 6 = Drive motors
- 7 = Switch box, platform
- 12 = Brake release lever
- 13 = Safety gear
- 14 = Automatic lubrication device

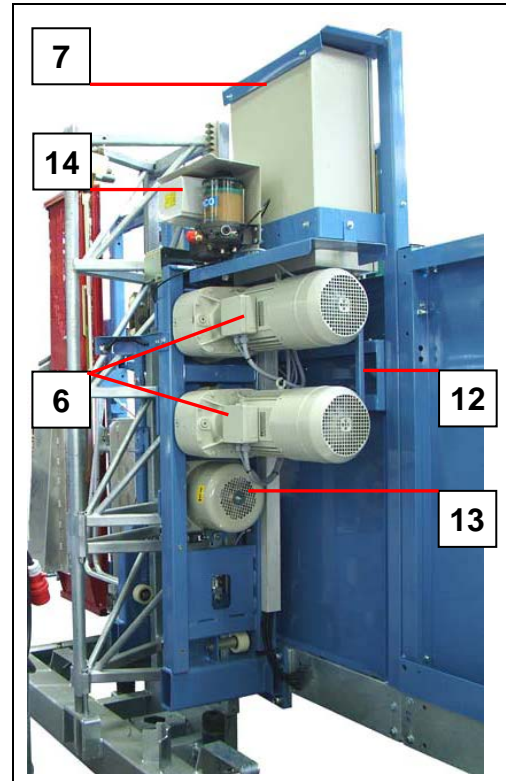

Securing the lowest stop

The lowest stop must be secured and indicated to prevent unauthorized access. The **GEDA ERA 1200 Z/ZP** must not be operated without such a cordoned-off area.

The distance of the cordoned-off area to moving hoist parts must be a minimum of 50 cm.

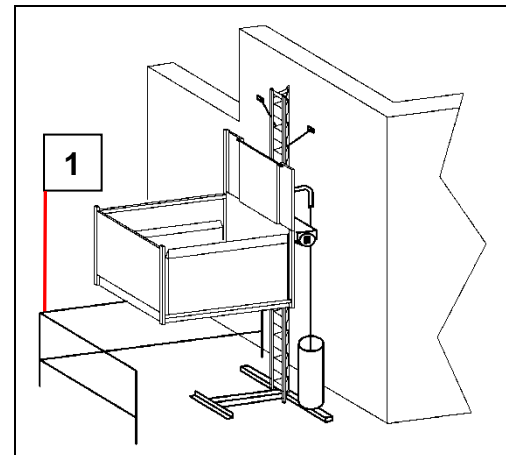

	DANGER
	<p>Danger to life By crushing. Never remain inside the cordoned-off area during operation. Turn off the main switch and secure it from being switched on whilst working inside the cordoned-off area.</p>

3.2.1 Ground station switch box

- 1 = Main switch
- 2 = Ready for service control light
- 3 = Socket (blue) for ground control (Manual control)
- 4 = Socket (red) for electric module on the landing-level safety doors (or dummy plug during assembly)

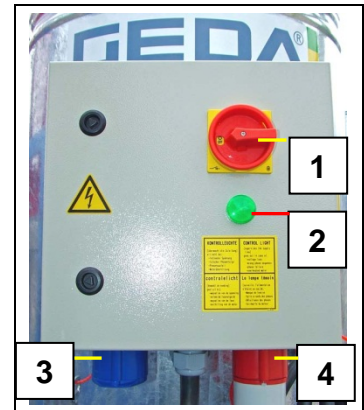

3.2.2 Switch cabinet with platform control

- 1 = **EMERGENCY STOP** button
- 2 = **UP** button
- 3 = **DOWN** button
- 4 = **LEVEL STOP** button
- 5 = Key switch
 - ➔ Position down (0) Manual control or landing level control is active.
 - ➔ Position down (1) Platform control is active
- 6 = Earthing contact socket 230V/16Amp
- 7 = Hinged plate
 - ➔ top operating mode transport platform
 - ➔ bottom operating mode construction hoist
- 8 = Lock for latching the cover

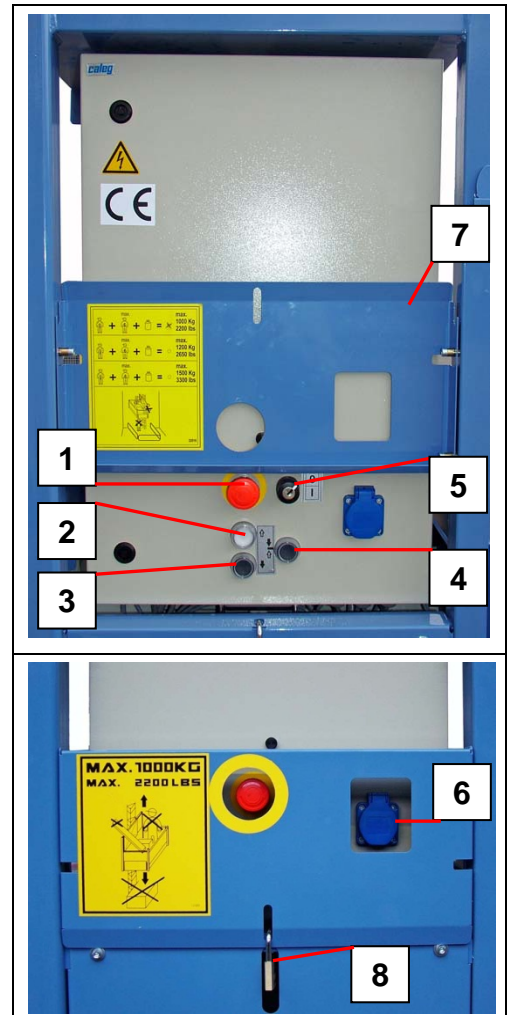

3.2.3 Ground control (manual control)

- 1 = **EMERGENCY STOP** button
- 2 = **Selector switch** MANUAL (I) - AUTOMATIC (II)
- 3 = **UP** button
- 4 = **DOWN** button
- 5 = Hanging bracket

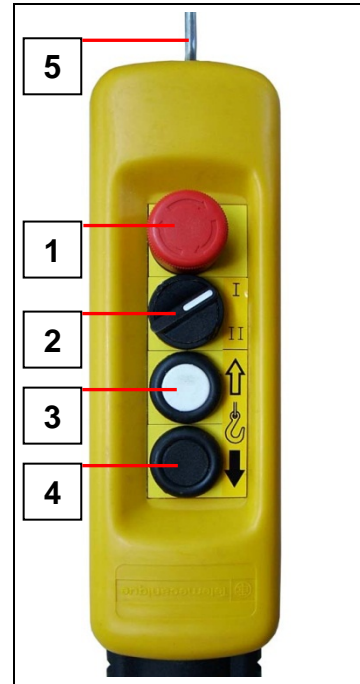

3.2.4 Drop-test control

(For exclusive use by authorised personnel).

The drop-test control is located in the switch cabinet of the platform.

The drop-test control unit serves the sole purpose of performing a drop test or of travelling upwards if the car has travelled too far down.

- 1 = **EMERGENCY STOP** button
- 2 = **Brake release** button
- 3 = Selector switch drop-test control **ON / OFF**
- 4 = **UP** button
- 5 = **DOWN** button

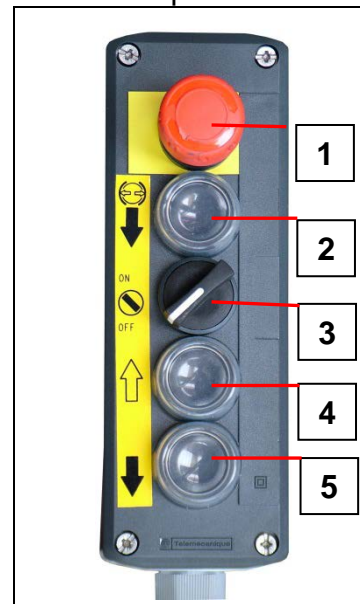

3.2.5 Platform access, ground station

The loading door (1) can only be opened if the platform is stationary on the ground (stopped by the down limit switch).

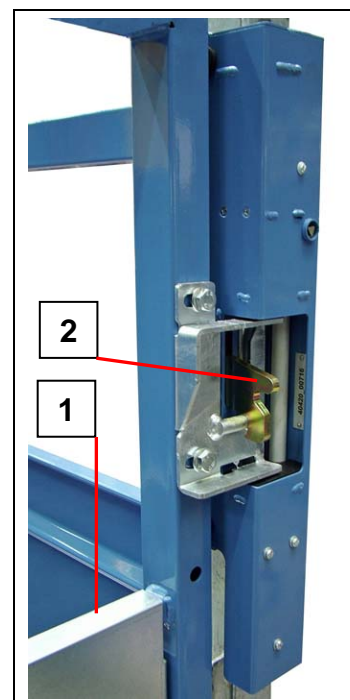

Emergency release

In case of a power failure, the platform access can be manually unlocked at the ground station.

- Insert the triangular wrench (3) into the lock.
- Turn the key and lift/lower the locking bar (2).
- Carefully open the loading door.
- Remove the key.

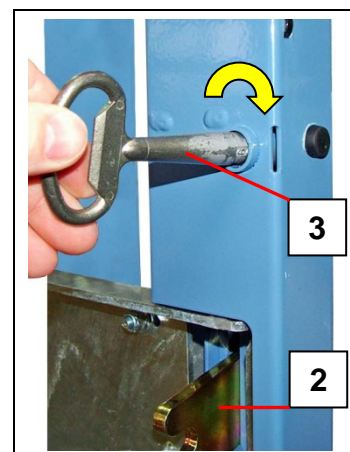

3.2.6 Platform access, building

The platform access (barrier) to the building can only be opened when the platform is actually at the landing.

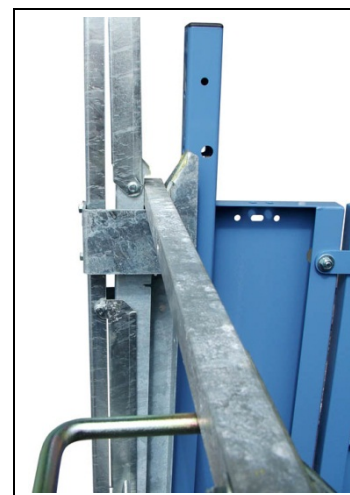

Overrun and cable protection

The proximity switch (2) switches off before the drive pinion leaves the gear rack (e.g. during assembly) or before the traction on the trailing cable holder (1) is too great.

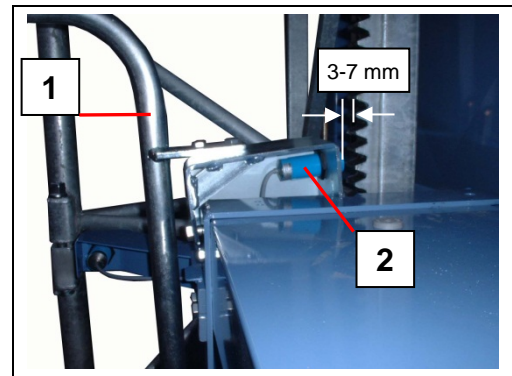

The correct distance from proximity switch to gear rack is 3-7 mm

3.2.7 Document box

The document and tool box should contain.

- Operating and maintenance manual for the machine
- Spare parts lists
- Circuit diagrams
- Operating instructions of the operating company
- Rescue plan of the operating company

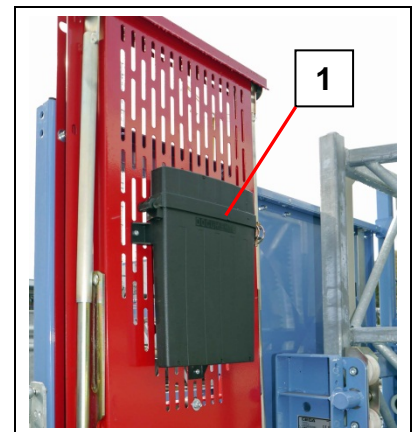

3.3 *Equipment as accessories*

3.3.1 **Assembly bridge**

The assembly bridge (1) is a small, fold-out platform, which aids anchoring the mast sections from the platform (can also be used in front of a facade without frontal scaffolding).



The assembly bridge must only be used during assembly and dismantling.

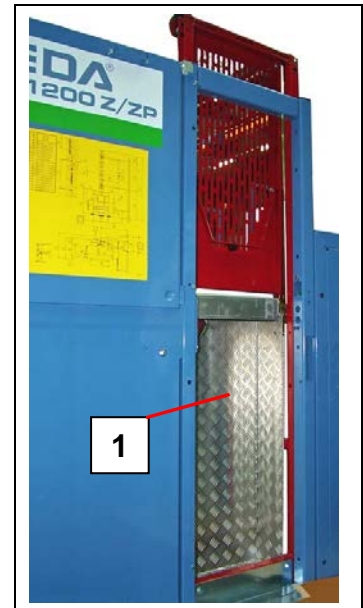

3.3.2 **Auxiliary assembly bridge for platform extension (only for platform "C")**

In order to access the wall anchorings on platform "C", an auxiliary assembly bridge (2) can be mounted onto the platform extension.



The assembly bridge must only be used during assembly and dismantling.



3.3.3 Electric module for landing level equipment

The electric module must be installed on the landing level equipment when local regulations specify electrical monitoring of the landing level sliding door or control of an upper stop is required.

1 = **EMERGENCY STOP** button

2 = **UP** button

3 = **DOWN** button



Comprehensive instructions for assembly is in the assembly manual.

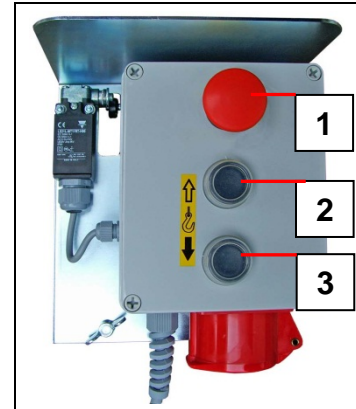

3.3.4 Roof

Function:

For protection from direct sunlight/rain, and for protection from small falling parts.



The roof must be removed for assembly of the mast sections.

3.3.5 Underride protection

Function:

To protect the hoist against damage resulting from driving into obstacles.

To protect people anomalously standing beneath the platform from crushing when the platform moves downwards.



When the underride protection is active, control is interrupted by a limit switch which makes travel impossible.

3.3.6 Ground base enclosure with barriers

The lowest stop position can be secured against unauthorized access by the base enclosure.

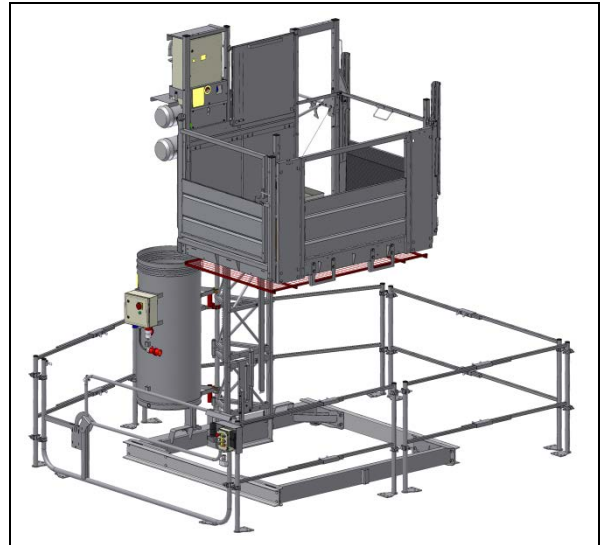

3.3.7 Front platform access points

Ramp / door (1.4 m) for front loading

An additional ramp (1) or loading door (2) can be installed on the front of the platform.

Function, refer to section 3.2.5

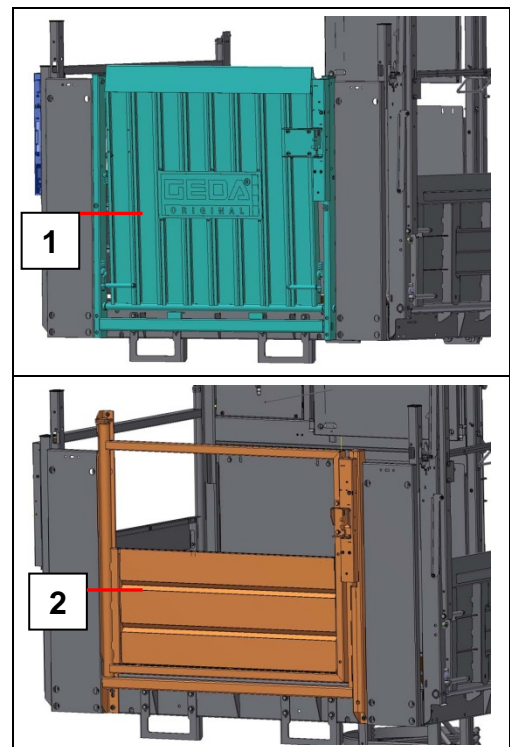

Ramp with scissor-type railing (1.4 m)

A ramp with scissor-type railing can also be installed on the front of the platform.

Function, refer to section 3.2.6

Mounting

Installation of a front ramp is described in a separate manual.

3.3.8 Mast assembly aid

Function:

For lifting and positioning mast sections during assembly/disassembly.



3.3.9 Central spindle

The central spindle (1) can be installed in the foot section support (2) beneath the mast, in order to transfer the forces (see ground pressure) without building an underlay on the foundation.

- 1 = Central spindle
- 2 = Foot section

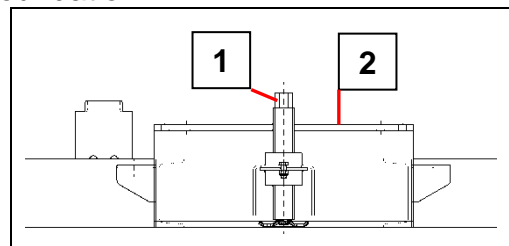

3.3.10 Cold package

The **GEDA ERA 1200 Z/ZP** can be used to -20 °C. In countries where work is carried out at lower temperatures, it is recommended to install a cold package.

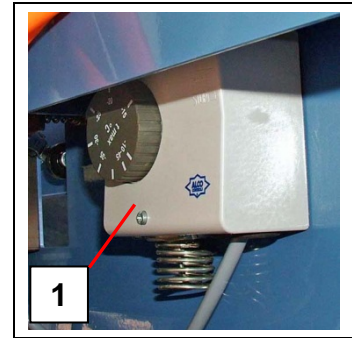

A thermostat (1) on the side of the platform mast, switches off upward travel at temperatures of less than -20 °Celsius.

3.3.11 Operating time indicator

An operating hours counter (1) can be installed in the trolley switch box to record the operating hours (motor operating time).



The switch box must be opened to read the counter

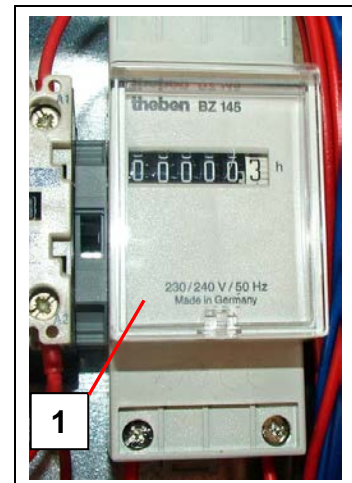

3.4 *Technical Data*

3.4.1 **Operating and environmental conditions**

The machine must only be operated when the following operating and environmental conditions are satisfied:

Temperature range:	minimum	-20 °C
	maximum	+40 °C
Wind speed:		
Operation/maintenance/servicing	maximum	72 km/h
Installation	maximum	45 km/h

Weather conditions:
No storms with risk of lightning.

It may be necessary to cease/prohibit operation of the machine under extreme weather conditions, even if the operating and environmental conditions are within the conditions stated. For example, by the combined occurrence of heavy frost and storm. Here, the operating company must provide appropriate regulations.

Atmosphere:

Transporting persons:

The atmospheric composition must be appropriate for persons in this area. In particular, reduction in the oxygen concentration as a result of displacement or consumption must be prevented. The legal limit values for pollutant concentrations/aerosols and dust in the workplace must not be exceeded.

Transporting material:

When transporting material, no concentration of abrasive/corrosive substances and of explosive fine particulate matter must occur. If this cannot be safely excluded, then the corrosion protection and/or the functional reliability of the electrical components must be inspected at regular intervals and, if necessary, replaced. Fine particulate matter must be removed.

3.4.2 Speeds

Lifting speed

construction hoist
(Outside control) 24 m / min.

Transport platform / assembly
(Platform control) 12 m/min and 24 m / min.

In the lower safety area
(0 – 2 m) 12 m / min.

Safety gear (FV32)

Triggering speed 32 m / min.

3.4.3 Electrical connected loads

A site distribution cabinet (in accordance with IEC 60439-4:2005) with fuse protection of the supply point

min. 32 A slow-blow and a

Residual current circuit breaker (RCD) with a rated current of **max. 0.03 A** is required

Base unit

Operating voltage 400V/50Hz / 3 x 32A (35A) / 3 Ph
Protection class IP 54 (NEMA 3)

Drives

400 V / 50 Hz

Rating 2 x 3 / 6.1 kW (6.0 / 12.2 KW)
Power consumption 2 x 7.5 / 13.8 A (15 / 27.6 A)
Start-up current (max.) 95/ 60 A
Switch-on period (ED) S3 (60 %)

3.4.4 Assembly height

Max. assembly height 100 m

3.4.5 Emissions

Sound level < 78 L_{PA}

3.4.6 Mast



Only original GEDA mast sections (Item No. E020300) must be used.



Length	1.5 m
Weight	82 kg
Connecting bolts	4 bolts M 16 x 180 8.8, 2 nuts M 16, 4 washers 17
Tightening torque	150 Nm (width across flats 24 mm)
First mast tie	≤ 9 m
Vertical distance mast ties	≤ 9 m
Vertical distance travelling cable guide	≤ 6 m
Max. protruding mast length:	
Operation	4,5 m
Assembly	9 m

3.4.7 Load capacity, Dimensions and weights



The installation of optional equipment (such as e.g. roof, assembly bridge, etc.) increases the tare weight. The load capacity decreases accordingly.

Platform A (1.4 m x 2.0 m)

Load capacity (max.)

Construction hoist	1500 kg	
Transport platform	1500 kg	1400 kg + 1
	(max. 7 persons)	1300 kg + 2
		1200 kg + 3
		1100 kg + 4
		1000 kg + 5
		900 kg + 6
		800 kg + 7

Assembly 600 kg

Space requirements (width x depth x height) with open loading ramp and doors approx. 3.87 m x 2.85 m x 2.32 m/
(2.75 m with roof)

Weights

Base unit and platform	1312 kg
with cable bin 30 m	1384 kg
with cable bin 50 m	1402 kg
Line per 25 m	+ 19 kg
Roof	51 kg

Platform B (1.4 m x 2.6 m)

Load capacity (max.)

Construction hoist	1200 kg	
Transport platform	1200 kg	1100 kg + 1
	(max. 7 persons)	1000 kg + 2
		900 kg + 3
		800 kg + 4
		700 kg + 5
		600 kg + 6
		500 kg + 7

Assembly 600 kg

Space requirements (width x depth x height) with open loading ramp and doors approx. 4.72 m x 2.85 m x 2.32 m/
(2.75 m with roof)

Weights

Base unit with platform	1383 kg
with cable bin 30 m	1454 kg
with cable bin 50 m	1472 kg
Line per 25 m	+ 19 kg
Roof	69 kg

Platform C (1.4 m x 3.2 m)

Load capacity (max.)

Construction hoist

1000 kg

Transport platform

1000 kg

900 kg + 1 ♂

(max. 7

800 kg + 2 ♂

persons)

700 kg + 3 ♂

600 kg + 4 ♂

500 kg + 5 ♂

400 kg + 6 ♂

300 kg + 7 ♂

Assembly

600 kg

Space requirements

(width x depth x height)

with open loading ramp and doors

approx. 5.03 m x 2.85 m x 2.32 m/

(2.75 m with roof)

Weights

Base unit with platform

1454 kg

with cable bin 30 m

1526 kg

with cable bin 50 m

1544 kg

Line per 25 m

+ 19 kg

Roof

71 kg

Assembly bridge

Load capacity 100 kg

Weight

40 kg

Mast assembly aid

Load capacity 100 kg

Weight

27 kg

Lifting beam

Load capacity 3000 kg

Weight

30.2 kg

Central spindle

Load capacity 8500 kg

Weight

6.8 kg

4 Operation



The GEDA ERA 1200 Z/ZP must only be operated by a competent person, specifically appointed by the operating company. This person must be familiar with the instruction manual, sufficiently experienced and instructed about the pending dangers when handling hoists.

Operating personnel see Chapter 1.7.2

4.1 *Safety during operation*

- Also observe the safety instructions in Chapter 2.
- Load the platform as centrally as possible, observe the load capacity of the equipment.
 - The platform must always be loaded in such a manner that the loading and unloading access points and the control point remain accessible.
 - Position the load carefully on the platform; material that might tend to slip or is higher than the platform, or which could fall over, must be secured (consider the possibility of sudden winds).
 - Do not transport bulky parts that project over the side of the platform.
- Do not stand or work under the platform!
- Do not place objects underneath the platform.
- Store material at a safety distance of min. 50 cm from moving parts of the machine.
- The landing level safety doors can only be opened once the loading ramp has been completely opened.
- If the loaded platform stops during operation due to a malfunction, then it is the responsibility of the operator to recover the load. - Never leave a loaded platform unattended!
- Operation of the transport platform must cease under the following conditions:
 - Temperatures of less than -20 °C and more than +40 °C.
 - there is damage or other malfunctions.
 - A recurring inspection has been missed (refer to the maintenance manual).

4.1.1 Special safety instructions for operation as a material hoist

- Transporting persons is prohibited!
- Switch to transport platform to carry out assembly and maintenance tasks.
- Operation of the material hoist must take place outside the danger zone.
- The operator must always be able to observe the platform.

4.1.2 Special safety instructions for operation as a transport platform

- Operation of the transport platform must be carried out exclusively from the platform control.
- Particular care is required near ground level.
- A max. of 7 person (including the platform operator) may be transported, whereby the corresponding proportion of transported materials must be reduced.
- Comply with the instructions of the platform operator.
- Do not reach or lean out over the platform sides.
- Do not step over material that is being transported.



The brake release lever must never be used to lower the platform during operation. It is intended only for use in emergencies (refer to Chapter 5.4.2).

4.1.3 Safety check before starting work

Perform a test run with an **empty** platform and check that the entire travel path of the platform is clear.

The platform must immediately stop when

- an **EMERGENCY STOP** button is pressed.
- the **UP** limit switch is triggered
- the **DOWN** limit switch is triggered
- the **EMERGENCY** limit switch is actuated.
- when the trolley has reached the mast end (only during assembly).

The platform must not start if

- it is overloaded (pulsating warning tone sounds).
- the barrier with unloading ramp is open.
- the loading door / ramp is open (the loading door / ramp must only be able to be opened at the ground station).
- the assembly guard is lowered
- the assembly bridge is open
- the safety gear has triggered.
- the landing gate is open (only when using the electric module).

Alarm signal function test

- When descending, the platform must stop approx. 2 m above the ground. Thereupon a warning signal must sound for approx. 3 seconds. (During this time the control function is blocked). Likewise, the warning tone must sound each time downwards travel below 2 m is initiated.

The platform must not continue to operate automatically when used as a material hoist, if

- the selector switch on the ground control is set to "I".
- the platform is located at ground proximity (approx. 2 m) independent of the selector switch position.



When operated as a material hoist and at ground proximity (approx. 2 m), the **GEDA ERA 1200 Z/ZP** must not be able to be operated from the landing-level safety door.

4.2 *Operation of the platform access points and the landing-level safety doors*

4.2.1 Base enclosure barrier (option)

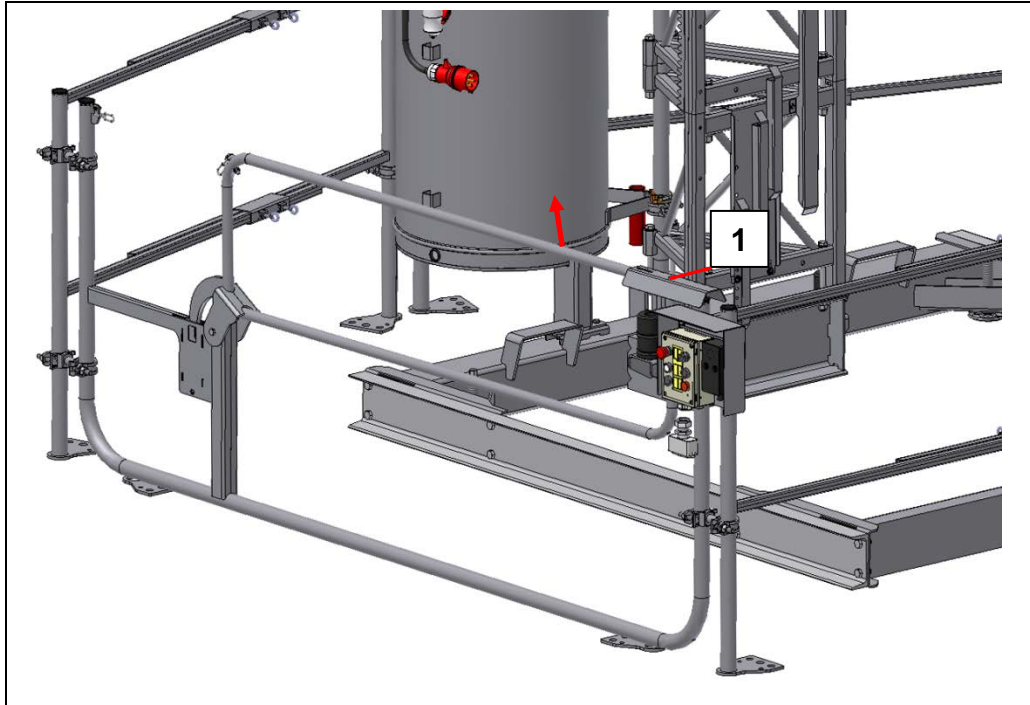

Open

- Raise the barrier (1) up.

Close

- Lower the barrier (1) until it lies on the enclosure posts.

4.2.2 Loading door / Ramp



This access point to the platform can only be opened if the platform is stopped by the down limit switch at the ground station.

Open

- Push / pull the loading door / ramp inwards with one hand.
- Lift/lower the locking hook (1).
- Open the loading door or carefully lower the ramp.

Close

- Close the loading door and push / pull inwards or carefully lift the ramp until the locking bar (1) is engaged.



4.2.3 Barrier with loading door

 This access must only be opened when the car is located at the landing level in front of a landing level safety gate.

Open

- Push / pull the barrier (2) towards the platform and swing it up.

The loading door opens automatically and presses downwards the brim plate of the landing level equipment.

Close

- Carefully lower the barrier (2) until it engages in the lock (3).

The loading door closes automatically.

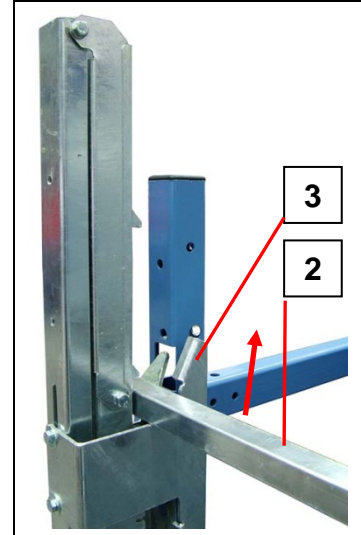

4.2.4 Landing door

Open

- Press the lever (4) in the direction of the arrow and push open the sliding door (5).

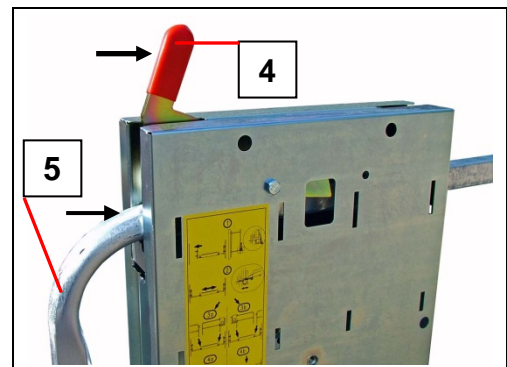

Close

- Close the sliding door (5), until the lever (4) engages downwards.

4.3 **Operating as a material hoist**

The loading door / ramp, barriers with unloading ramp and assembly bridge must be closed and engaged. The assembly guard must be properly hung up.

- On the switch box of the ground station, switch on the main switch (Position "I" (ON).
- Turn the key in the key switch on the platform control to the left (position **0**) and remove the key.
- Slightly lift the hinged plate (6) (platform control cover), fold it downwards, where it should be re-lifted and engaged in place.
- Secure the hinged plate with a lock (7).

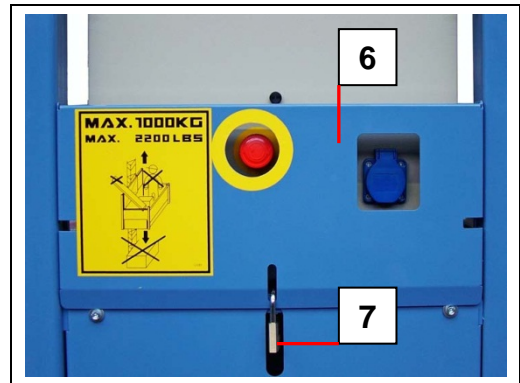

The ground control and electric modules of the landing level safety doors are active.

The machine can now be used as a material hoist.

The platform speed is approx. 24 m/min. (12 m/min. in lower safety range).

Dead man's control

- **Selector switch (2) to position "I"**
 - The platform moves only as long as the UP (3) or DOWN (4) buttons are pressed.
- The platform **overruns** the landing level limit switch approach bar and is stopped by the **UP** limit switch.

1 = **EMERGENCY STOP** button

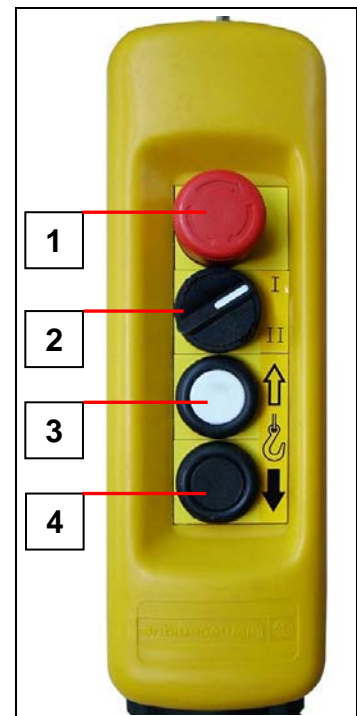

 The platform can be only be operated above the initial 2 m safety height with the “UP” (3) or “DOWN” (4) buttons using the electric module.

8 = **STOP** button (does not engage)

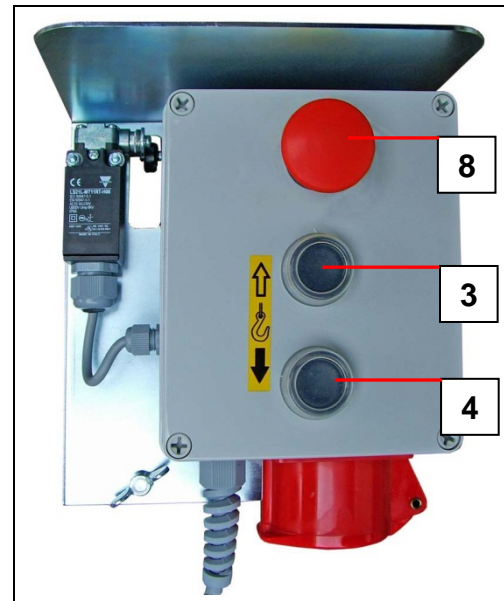

Automatic travel to a landing level

- **Selector switch (2)** to position “II”

Ascent

- The platform travels within the lower 2.0 m from the ground (safety height) only as long as the **UP** pushbutton (3) is pressed. After passing this safety height, the **UP** button (3) must be released and the platform will travel automatically to the next landing level and stop there.
- For continuous through-travel to the “second landing”, hold the **UP** button (3) pressed until the limit-switch approach bar for the first landing is overrun.

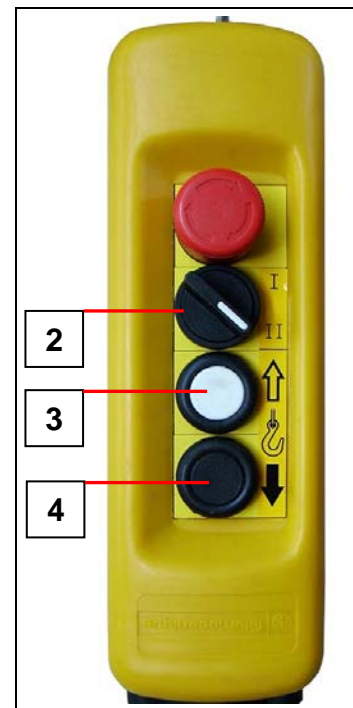

Descent

- Press and release **DOWN** button (4). - The platform travels down and stops in front of the 2.0 m safety area. A warning tone sounds for approx. 3 seconds.
- The remaining 2.0 m can only be traversed with the ground control and with the **DOWN** button (4) held pressed (dead man's control).

4.4 Operating as transport platform

The transport platform can be operated from the platform only in dead man's control. The platform only operates for as long as the operating button is pushed.

The platform may be accessed and exited only at the installed landing level safety doors above 2m.

The ramp, barrier with unloading ramp and assembly bridge must be closed and engaged. The assembly guard must be properly hung up.

- Turn the main switch (on the switch box of the ground station) to "I" position (ON).
- Remove the lock that secures the cover.
- Slightly lift the hinged plate (6) (platform control cover), flip it up and hang in place.
- Insert the key (5) into the key switch and turn to the right (position 1) to activate the platform control.

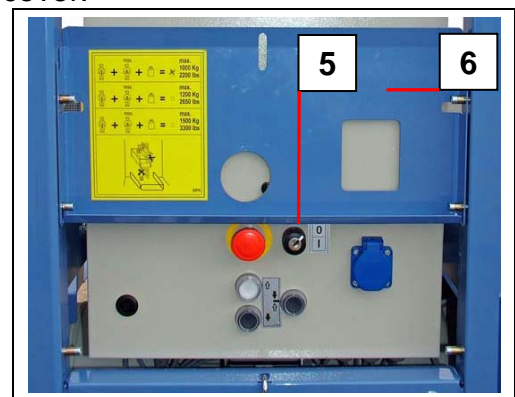

☞ **Only the platform control is active.**

The machine can now be used as a transport platform or for assembly.

The speed of the transport platform is approx. 24 m/min. (12 m/min. in the lower safety area)

Ascent

- To move the platform upwards, press and hold the **UP** button (2).

1 = **EMERGENCY STOP** button

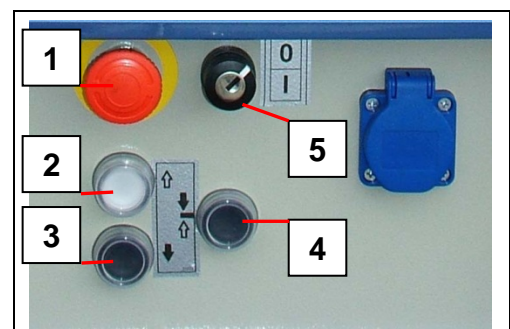

Stopping the platform in its ascent:

- Release the button **UP** (2).

Platform reaches the upper limit-switch approach bar and automatically stops (the UP limit switch switches off).

If the platform is to be excited at a transfer point (landing level equipment) for loading and unloading, the platform must be stopped so that it is level with the landing level safety door.

- If a landing bar is set (refer to the assembly instructions), the platform can also be stopped with the **LANDING STOP** button (4), which is pressed in addition to the **UP** button before reaching the landing-level safety door.
- Initially release the direct button (2, 3) and then the **LANDING STOP** button (or both simultaneously).



Always approach landing-level limit-switch approach bars from below.

Descent

- To move the platform downwards, press and hold the **DOWN** button (3).

Stopping the platform during descent:

- Release the **DOWN** (3) button.

The platform descends and stops automatically approx. 2 m above the ground.



The platform operator may continue the descent only after it has been ensured that the travel path below is clear.

- Again press and hold the **Down** button (3), this will release a warning tone, after approx. 3 seconds the platform will move and stops at the **DOWN** limit switch.

4.5 **Emergency shutdown**

In situations that present a risk to operating personnel or the transport platform, the platform can be shut down by pressing an **EMERGENCY STOP** button (1).

An **EMERGENCY OFF** button is located on the

- platform control,
- Ground control
- drop-test control.



EMERGENCY STOP slam buttons are equipped with a latching mechanism and remain active until they are manually unlocked again (turn red button to the right and pull it out).



A stop button is located on the electric modules of the landing level safety doors and is used to stop travel from each storey. This stop button does not engage which means that further travel is immediately possible after the stop command.

4.6 **Interrupting work – end of work**

- Move the platform downwards until it stops at the **DOWN** limit switch.





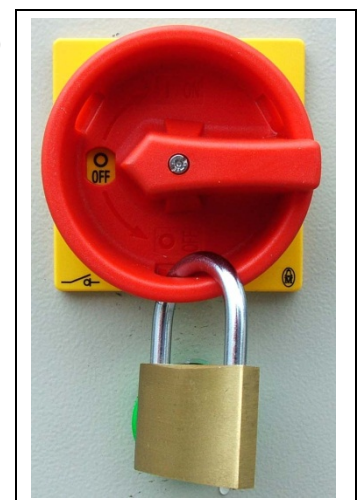

If there is a risk of frost, move the platform up a little, so that the down limit switch is clear.

- Unload the platform.
- Remove the key from the key switch of the platform control.
- Lower the hinged plate on the platform control and secure with a lock.
- Turn off the main switch (Position “0” [OFF]) and secure with a padlock.
- Disconnect the mains plug.



5 Malfunctions - Diagnosis – Repair

	<p>WARNING</p> <p>Only have troubleshooting and fault elimination carried out by authorised personnel trained especially for this kind of work. Before troubleshooting, if possible, lower the platform and unload! Immediately discontinue operation if faults occur that endanger operational safety!</p>
 	<p> DANGER</p> <p>Electric shock Shut off and secure the main switch before working on the electrical system of the transport platform. Remove the mains plug for safety reasons.</p>

5.1 Diagnostic system (option)

The diagnostic system is used for quick and easy identification of the switching statuses of the limit switches and **EMERGENCY OFF** buttons.

After input of the travel command, only the green diode must illuminate.

If this is not the case, the corresponding function or corresponding limit switch must be checked.

Switching status of the LED

- green LED = standard **ON**
- yellow LED = standard **OFF**

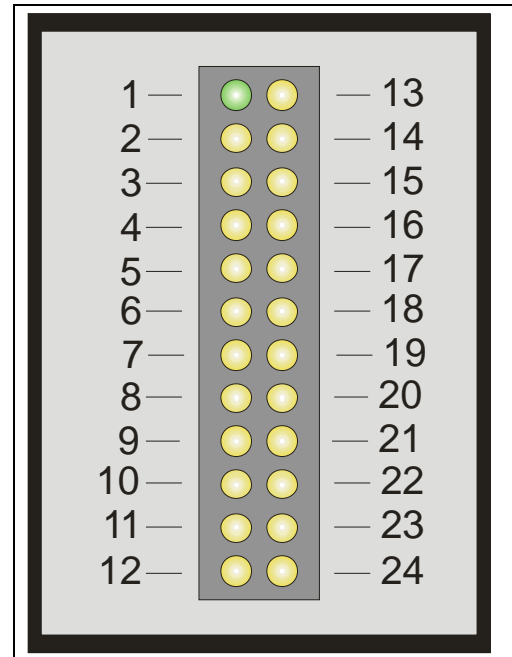

Troubleshooting using the Diagnostic system

LED No.	Significance of LED
1	Diagnostic system OK / READY
2	Illuminates when the EMERGENCY OFF button of the platform control is activated.
3	Illuminates when the EMERGENCY OFF button of the drop-test control is activated.
4	Illuminates when the limit switch of the safety gear is activated.
5	6 = Illuminates when the EMERGENCY limit switch TOP or BOTTOM is activated.
6	Illuminates when the platform access to the building (barrier with loading door) is not locked.
7	-
8	Illuminates when the platform access ground station (double door/ramp) is not locked.
9	Illuminates when the second (on the front) platform access ground station (double door/ramp) is not locked.
10	Illuminates when the limit switch of the assembly guard is activated.
11	Illuminates when the limit switch of the assembly bridge 1 is activated.
12	Illuminates when the limit switch of the additional assembly bridge 2 is activated. (Only for platform "C")
13	Illuminates when the limit switch of the collision grille 1 is activated.
14	Illuminates when the limit switch of the collision grille 2 is activated.
15	Illuminates when the UP limit switch is activated.
16	Illuminates when the DOWN limit switch is activated.
17 - 24	-

5.2 **Fault table**

In the following table you will find potential faults and the appropriate remedial action.

Fault	Cause	Remedial action
<p>Green control light off</p> 	<p>Mains plug disconnected</p> <p>Main switch off</p> <p>Illuminant defective</p> <p>Phase failure</p> <p>Incorrect phase sequence</p> <p>Travelling cable connected</p> <p>Fuses in the switch box ground station okay</p>	<p>Connect mains plug</p> <p>Switch on the main switch</p> <p>Replace illuminant</p> <p>Measure the phases</p> <p>Correct the phase sequence on the phase sequence monitor</p> <p>Plug in the travelling cable</p> <p>Check/correction</p>
<p>Green indicator lamp illuminates, platform does not move</p>	<p>EMERGENCY STOP button (at a control point) pressed</p> <p>Loading door / ramp open</p> <p>Barrier with loading door open</p> <p>Assembly guard plate open</p> <p>Assembly bridge open</p> <p>EMERGENCY limit switch has activated</p> <p>Base enclosure barrier open (Option)</p> <p>Safety gear engaged</p> <p>Key switch on the platform control switched to incorrect operating mode</p>	<p>Unlock the EMERGENCY OFF button</p> <p>Close loading door / ramp</p> <p>Close barrier with loading door</p> <p>Attach assembly guard plate at the top</p> <p>Close the assembly bridge and engage safety hook twice</p> <p>Refer to Platform moved too high / too low</p> <p>Close base enclosure barrier</p> <p>Release safety gear (refer to Chapter 5.3.5)</p> <p>Activate control using key switch</p>
<p>Platform only moves upwards</p>	<p>Is the DOWN limit switch functional?</p>	<p>Check/replace DOWN limit switch</p>
<p>Platform only moves upwards</p>	<p>Is the UP limit switch functional?</p> <p>Excess distance of proximity switch for monitoring gear rack</p>	<p>Check/replace UP limit switch</p> <p>Adjust the clearance to the gear rack (3-7 mm)</p>

Fault	Cause	Remedial action
Pulsing signal sounds	Overload protection has triggered	Reduce the load
Motor does not attain full performance	Voltage drop of more than 10 %	Select a supply cable or extension cable with a greater cross section
Platform has ascended too high (Refer to Chapter 5.3.2)	Top landing-level limit switch defective	Test/replace top landing-level limit switch
Platform has run too low (Refer to Chapter 5.3.3)	Fault in the electrical system	Check system
	Fault in the electrical system	Check system
	Brake air gap is too large	Adjust air gap
The platform access door ground station does not open.	Platform is stationary, not stopped by the DOWN limit switch	Move platform to the DOWN limit switch
	Door lock defective	Door EMERGENCY unlock. Replace defective lock
	No voltage	Connect power supply

5.3 **Fault rectification**

5.3.1 **Motor is not producing full output**

- Voltage drop of more than 10 % of the rated voltage.
- Select a supply cable with a greater cross-section.
- If overloaded, the integrated thermal switch turns off the control current. Work can continue after a certain cool-down period (possibly reduce load).



Refrain from repeated overheating/overloading. - Otherwise the service life of the motor/brakes will be shortened.

5.3.2 **Platform moved too high**

The platform **EMERGENCY** limit switch can reach the upper **EMERGENCY** limit switch bar if

- The up limit switch is defective,
- there is a malfunction in the electrical system.

Action:

- Operate motor brake using the manual release lever (refer to Chapter 5.4.2)

5.3.3 Platform has run too low

Cause

The platform **EMERGENCY** limit switch can reach the lower **EMERGENCY** limit switch bar if

- Brake air gap is too large
- The DOWN limit switch is defective,
- there is a fault in the electrical system,
- the platform is overloaded,
- the platform was lowered with the manual brake release.

Actions:

- Remove the hinged plate from in front of the switch cabinet on the trolley.
- Open the switch box on the trolley and remove the droptest control (1).
- Switch the selector switch to the position “ON”.
- Press the **UP** button (2) outside the platform. Now the platform moves out of the LIMIT position.

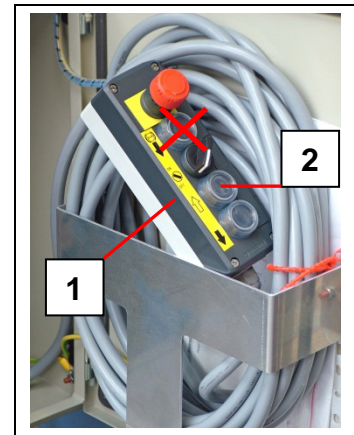

The “UP” button (1) must be pressed, because this control bridges the Emergency limit switch. If the drop test control button is inadvertently pressed, the motor brake releases and the motor can drop hard onto the foot section (risk of damage).

- After “neutral” running, turn the selector switch back to “OFF”.
- Return the control to the switch box and close the cover.
- Re-attach the hinged plate in front of the switch cabinet.



If this effect occurs repeatedly although the platform is not overloaded, have the brake checked or adjusted by a qualified person.

5.3.4 Overload warning device has triggered

The platform is equipped with an overload warning device which prevents the platform from being operated when it is overloaded. If the platform is overloaded, a pulsing acoustic signal will sound.

- Reduce the load on the platform until the signal is silenced. - Only then is travel possible again.

5.3.5 Safety gear has triggered

The transport platform is equipped with an overspeed safety device that halts the platform if overspeed is detected. Further travel is not possible once the safety gear has been triggered.

WARNING	
	<p>Danger to life All persons must exit the platform Determine why the safety gear has engaged, secure the platform and repair the damage before releasing the safety gear!</p> <p>The safety gear must only be triggered by a competent person specifically appointed by the operating company who, due to his/her training, knowledge and practical experience, is able to evaluate the risks and assess the safe condition of the safety gear.</p>



Downward travel is mechanically blocked by the safety gear and may be pressed again only after a brief ascent!

Releasing the safety gear (only by a qualified person)

- Remove the hinged plate from in front of the switch box on the trolley.
- Open the switch box on the platform and remove the drop test control (1).

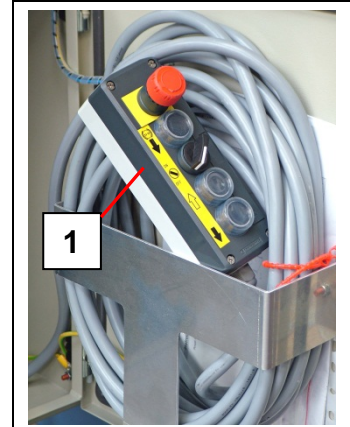

- Switch the selector switch (2) to the position "ON".
- Press the **UP** button (3) from outside the platform and move the platform up by approx. 20-30 cm.
- After "neutral" running, turn the selector switch back to "OFF".
- Return the control to the switch box and close the cover.
- Re-attach the hinged plate in front of the switch cabinet.

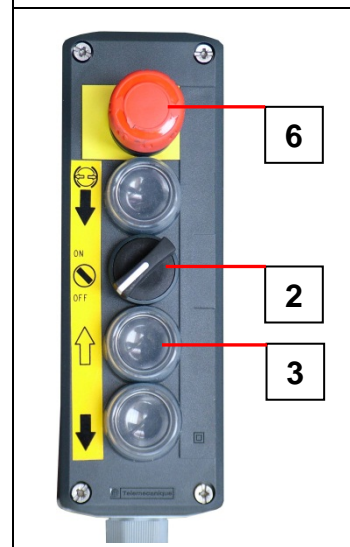

- Remove the cover plate (4) below the switch box for the platform control.

Width across flats (AF) = 13mm



- Release the lock nut (5) on the safety gear.
- Turn the safety-gear protective cover (6) to the left until the limit switch lug (7) engages in the slot of the protective cover (6).
- Re-tighten the lock nut (5).

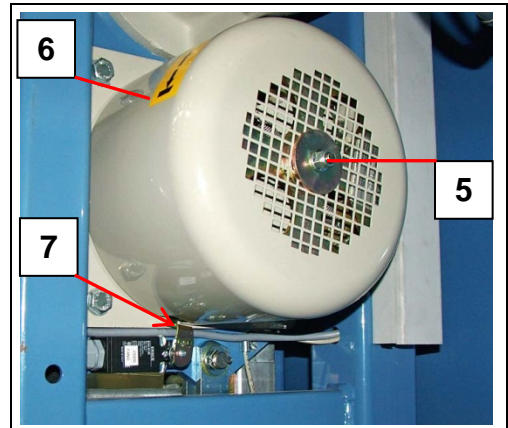

After the safety gear has activated, it must be checked for signs of damage. The check, carried out by a competent person, is described in the maintenance manual.

- Install the cover plate below the switch box of the platform control.

5.4 Retrieving the platform

Rescue may become necessary in the event that, for example:

- no mains voltage.
- Malfunctions of the electrical system.
- the drive has failed.
- the safety gear has triggered.

	WARNING
	If the supervisor/platform operator does not feel confident or qualified to organise and carry out the rescue, notify the relevant authorities (rescue personnel).

5.4.1 Basic conduct in the event of a rescue/malfunction

- Get an overview of the situation.
- Remain calm and do not act hastily.
- Be cautious and thorough when checking the situation!
 - Is anybody hurt?
- Keep unauthorised persons away.
- Make contact with anyone trapped.
- Try to find out the cause of the malfunction/defect in the system, e.g.:
 - Power failure
 - Trigger the safety gear
- As necessary, inform persons trapped about the planned procedure.
- Inform your superior about the malfunction.
- Inform any rescue services.



The sequence of measures can / must be varied by the attendant / rescue personnel depending on the specific situation

5.4.2 Rescue action plan

Action 1: Inspect the key switch.
This could have been accidentally actuated.

- Rotate the key switch (1) to position I.
- Press **BUTTON UP** (2) or **DOWN** (3) to continue travel.

The platform moves.

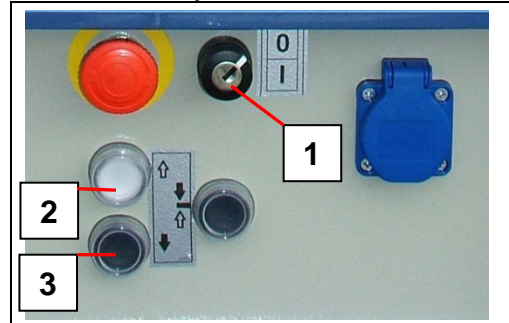

Action 2: Self-rescue using **EMERGENCY** lowering.

The **EMERGENCY** descent function is used only in an emergency to reach the next lower landing. Hereby, persons trapped can evacuate themselves



WARNING

Trigger the safety gear

The brake release lever must be operated extremely carefully, in order to prevent the safety gear from engaging. If the safety gear has engaged once, it will not be possible to progress any further without raising the platform.

- Lightly pull on the brake release lever (4) to release the motor brake. - The platform glides down.

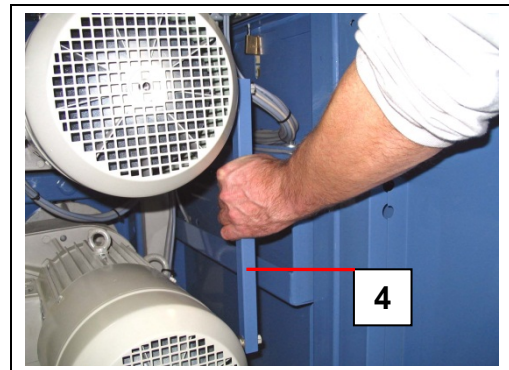

CAUTION

The brake becomes very hot.
Interrupt the lowering process for 2 minutes at the latest after every 1-2 meters. The length of a mast section can be used for orientation.

- When at the next landing, release the brake lever (4).
Stop so that the floor of the platform is slightly above the sill of the landing-level safety door.
- Exit the platform.



It is not possible to lower the platform by releasing the motor brake if, e.g. the safety gear has triggered.

	WARNING
	Now check to make sure that no parts of the drive system are broken, damaged or non-operational. In this case, the safety gear must not be released. The transport platform must be decommissioned!

Action 3: Rescue in accordance with the emergency / rescue plan of the operating company.



An emergency / rescue plan must be prepared by the operating company and kept in a clearly visible place on the transport platform!

5.5 *Repair*



Repair tasks must only be carried out by trained and competent persons because they require special expert knowledge and skills. Neither is communicated in this operating manual.

When ordering spare parts please provide the following:

- Type
- Year of manufacture
- Serial No.
- Operating voltage
- Quantity required

The nameplate is located on the trolley of the base unit.



Spare parts must conform to the technical specifications of the manufacturer! Only use original spare parts from GEDA.

For service or repair work, please contact our customer service department:

For the sales and customer service address, refer to Chapter 1.4

6 Disposal of the machine

Dismantle the equipment properly at the end of its service life and dispose of according to national provisions.

Observe the following when disposing of equipment components:

- Drain and dispose of oil/grease in an eco-friendly way.
- Recycle metal parts.
- Recycle plastic parts.

Recommendation:

Contact the manufacturer or commission a specialist company to handle disposal requirements in accordance with regulations.