



# Operating Manual

## **GEDA<sup>®</sup>** **MULTILIFT P12** **STANDARD / COMFORT**

### **Construction hoist**

For the transport of material and persons



# EC Declaration of Conformity



The manufacturer

**GEDA-Dechentreiter GmbH & Co. KG**

Mertinger Str. 60  
DE-86663 Asbach-Bäumenheim

hereby declares that the machine

Designation: **Construction hoist for personnel and loads**  
(for temporary, non-public use by authorised persons)

Type: **GEDA® MULTILIFT P12 COMFORT**

Year of manufacture: see type plate of the machine

Serial No.: 21M .....  
23M .....

is in compliance with all pertinent provisions of the following directives at the time of being put on the market.

<u>Directives:</u>	<u>Applied</u> <u>conformity evaluation</u> <u>procedure:</u>
2006/42/EC Machinery Directive	Appendix VIII
2006/95/EC Low Voltage Directive	Appendix IV
2004/108/EC EMC Directive	Appendix II
2000/14/EC Noise Emissions Directive	Appendix V

Applied (harmonised) norms:

EN ISO 12100:2010      EN 12158-1:2000+A1:2010  
EN 60204-1/32          EN 12159:2012

**EC type testing procedure:**

Type testing certification	NL 08-400-1001-068-04
European notified body	0400 LIFTINSTITUUT
	Buikslotermeerplein 381
	1020 MA Amsterdam

This EC conformity declaration becomes null and void if any changes are made to the aforementioned machine that have not been authorised by the manufacturer.

Authorised representative for technical documentation is the signatory.

Asbach-Bäumenheim 2012-02-10

Johann Sailer  
(Managing Director)

**Table of Contents:**

Chapter	Page
<b>1 General information</b> .....	<b>5</b>
1.1 Information about the instruction manual.....	5
1.2 Abbreviations .....	7
1.3 Information about the machine .....	8
1.4 Name and address of the manufacturer .....	8
1.5 Notes about the author and industrial property rights.....	9
1.6 Instructions for the operating company.....	10
1.7 Intended use .....	11
1.7.1 Requirements of assembly personnel.....	12
1.7.2 Operating personnel.....	12
1.7.3 Improper use .....	12
<b>2 General safety information</b> .....	<b>13</b>
2.1 Residual risks.....	13
2.2 Safety instructions for operating personnel.....	14
2.3 Safety instructions for transport .....	15
2.4 Safety instructions for operation .....	16
2.5 Safety instructions for servicing, maintenance and troubleshooting.....	17
2.6 Safety whilst working on the electrics .....	19
2.7 Tests.....	20
<b>3 Technical description</b> .....	<b>21</b>
3.1 Description of function.....	21
3.1.1 <i>Multilift P12 STANDARD</i> .....	22
3.1.2 MULTILIFT P12 COMFORT.....	23
3.2 Machine equipment.....	24
3.2.1 <i>GEDA MULTILIFT P12 STANDARD</i> .....	24
3.2.2 <i>GEDA MULTILIFT P12 COMFORT</i> .....	25
3.2.3 Trolley with drives.....	26
3.2.4 Ground-station switch box.....	27
3.2.5 Control at the ground station .....	28
3.2.6 Control at the levels.....	29
3.2.7 Car control.....	30
3.2.8 Emergency call system .....	31
3.2.9 Car lighting .....	32
3.2.10 Roof hatch .....	32
3.2.11 Car / enclosure doors .....	33
3.2.12 Box for documents and tools.....	34
3.3 Components as accessories .....	35
3.3.1 Car control with level pre-selection .....	35
3.3.2 <i>Base enclosure 1.10m for the GEDA-MULTILIFT P12 Standard</i> .....	36
3.3.3 <i>Collision grille</i> .....	38
3.3.4 Mast assembly aid.....	38
3.3.5 Drop test control .....	39
3.4 Technical Data .....	40
3.4.1 Operating and environmental conditions.....	40
3.4.2 Speeds .....	41
3.4.3 Electrical connected loads.....	41
3.4.4 Assembly height .....	41
3.4.5 Access height (threshold level) .....	41
3.4.6 Emission.....	41
3.4.7 Vibrations in the car.....	42
3.4.8 Mast.....	43
3.4.9 Data with car "A" (2.0m x 1.4m) .....	44
3.4.10 Data with car "B" (2.6m x 1.4m) .....	45
3.4.11 Data with car "C" (3.2m x 1.4m).....	46
3.4.12 Data with car "D" (3.2m x 1.4m).....	47

Chapter	Page
<b>4</b>	<b>Operation ..... 49</b>
4.1	Safety during operation ..... 49
4.2	Commissioning ..... 51
4.2.1	Safety check before starting work ..... 51
4.3	Operating the car accesses ..... 52
4.3.1	<i>Barrier of the base enclosure (MULTILIFT P12 STANDARD)</i> ..... 52
4.3.2	Sliding doors at the ground station and car ..... 53
4.3.3	Landing level safety door for sliding door with ramp ..... 56
4.3.4	Landing level safety door for sliding door with counterweight ..... 56
4.4	Operating the controls ..... 57
4.4.1	Control at the ground station ..... 57
4.4.2	Control at the levels ..... 58
4.4.3	Car control ..... 59
4.4.4	Car control with level pre-selection [option] ..... 61
4.5	Emergency shutdown ..... 62
4.6	Interrupting work – end of work ..... 63
<b>5</b>	<b>Malfunctions - Diagnosis – Repair ..... 64</b>
5.1	Diagnostic system (Option) ..... 65
5.2	Fault table ..... 66
5.3	Fault rectification ..... 68
5.3.1	Phase inverter ..... 68
5.3.2	Motors are not giving full output: ..... 68
5.3.3	Overload control light is on ..... 68
5.3.4	Car door or enclosure door/level door cannot be opened ..... 69
5.3.5	Car moved too high ..... 69
5.3.6	Car has moved too low ..... 70
5.3.7	Frequency converter has switched off ..... 71
5.3.8	Car does not recognise the level selected ..... 73
5.3.9	Safety gear has triggered ..... 74
5.4	Rescuing people / retrieving the car ..... 75
5.4.1	Basic conduct in the event of a rescue/malfunction ..... 75
5.4.2	Rescuing the car ..... 76
5.4.3	Rescuing persons trapped inside ..... 78
5.4.4	Exit the car over the assembly bridge. .... 79
5.5	Repair ..... 80
<b>6</b>	<b>Disposal of the machine ..... 80</b>

# 1 General information

## 1.1 Information about the instruction manual

This operating manual is an essential aid to operating the machine **successfully and hazard-free**.

This operating manual contains important instructions on how to operate the machine **safely, correctly and efficiently**. Compliance with these instructions helps to avoid hazards and increases the reliability and service life of the machine.

The operating manual must be **available at the machine at all times** and must be read and applied by every person commissioned to work on/with the machine, e.g.:

- Operating, fault rectification during work, disposal of operating materials and auxiliary supplies,
- Assembly, maintenance (servicing, general maintenance, repairs) and/or transport.

You will see a series of illustrations and symbols whilst reading this manual which are intended to help you navigate through and understand this manual. The different meanings are explained below.

Text display	Meaning
<b>Bold type</b>	Emphasises particularly important words/passages
• List 1	Denotes lists
- List 2	Denotes lists
(brackets)	Item numbers
➤ Instruction	Instruction to personnel Always given in chronological order

### Images



The illustrations used refer to a specific machine type. They may only constitute a schematic representation with other machine types. The fundamental function and operation is not affected by this.

The **structural elements** in this operating manual appear as follows and have the following meaning:



### Health and safety symbol

This symbol is found next to all safety instructions where there is a risk of injury or a fatality. Observe these instructions and be very cautious!

Warning level	Consequence	Probability
 <b>DANGER</b>	Death / serious injury	is imminent
 <b>WARNING</b>	serious injury	possible
 <b>CAUTION</b>	minor injury	possible
<b>CAUTION</b>	tangible damage	possible



### Attention note

This is found at points where special information or instructions and restrictions regarding damage prevention are given in order to prevent damage to the equipment.



### Note

This is found at points where information is given about using the machine economically or instructions are given regarding correct working procedures.

## 1.2 Abbreviations

The following abbreviations may be used in the manual.

max.	maximum	Nm	Newton metre
min.	minimum	km/h	kilometres per hour
mins.	minutes	mph	miles per hour
etc.	et cetera	inc.	including
poss.	possible/possibly	if nec.	if necessary
e.g	for example	i.e.	id est (that is)
ml	millilitre	reg.	regarding
mm	millimetre	RH	relative humidity
°C	degrees Celsius	approx.	approximately
°F	degrees Fahrenheit	∅	diameter
ft.	feet	®	registered trademark
ft/m	feet per minute	©	copyright
m/min	metres per minute	TM	trademark
in.	inch	%	per cent
etc.	et cetera	‰	per thousand
lbs.	pounds	dB (A)	sound pressure level
lb.-ft	pounds per feet	LWA	sound power level
kg	kilogram	>	greater than
l	litre	<	less than
gal.	gallons	±	plus or minus
kip	kilopound		

### 1.3 Information about the machine

<b>GEDA MULTILIFT P12</b>	<b>STANDARD / COMFORT</b>
Year of manufacture:	See identification plate on the machine
Serial number:	<b>21Mxxxxx / 22Mxxxxx / 23Mxxxxx</b>
Documentation version:	12/2014

### 1.4 Name and address of the manufacturer

GEDA Dechentreiter GmbH & Co. KG  
 Mertinger Straße 60  
 86663 Asbach-Bäumenheim  
 Tel.: +49 (0)9 06 / 98 09-0  
 Fax: +49 (0)9 06 / 98 09-50  
 E-Mail: info@geda.de  
 Web: www.geda.de

#### GEDA representatives

<b>Bergkamen Subsidiary</b>	<b>Gera Subsidiary</b>
GEDA Dechentreiter GmbH & Co. KG Northwest branch Marie-Curie-Straße 11 59192 Bergkamen-Rünthe Tel. +49(0)2389 9874-32 Fax. +49(0)2389 9874-33	GEDA Dechentreiter GmbH & Co. KG Subsidiary Eastern Ernst-M.-Jahr Straße 5 07552 Gera Tel. +49(0)365 55280-0 Fax. +49(0)365 55280-29
<b>USA Subsidiary</b>	<b>Russia Subsidiary</b>
GEDA USA, LLC 1151 Butler Road USA 77573 League City, Texas Tel. +1(713) 621 7272 Fax. +1(713) 621 7279 Web: www.gedausa.com	GEDA RUS, LLC Yaroslavskoe shosse 42 129337 Moscow Russian Federation Tel. +7(495) 663 24 48 Fax. +7(495) 663 24 49 Web: www.geda-ru.com
<b>Turkey Subsidiary</b>	
GEDA MAJOR IS VE INSAAT MAKINALARI SAN. TIC. LTD. STI. Semsettin Günaltay Cad. No:224 A Blok K:2 D:5 Tüccarbasi/Erenköy TR-34734 Istanbul/Türkiye Tel.: +90 (216) 478 2108 Fax: +90 (216) 467 3564 Web: www.geda.com.tr	



## 1.5 Notes about the author and industrial property rights

All documents are protected in terms of copyright law. Dissemination and reproduction of documents (even parts thereof), as well as recycling or communication of their contents are prohibited unless expressly permitted in writing.

Violations are an offence and incur an obligation to pay compensation. All rights to exercise industrial property rights are reserved by **GEDA**.

## 1.6 Instructions for the operating company

This operating manual is an essential component of the machine. The operating company must ensure that operating personnel are **informed** about these guidelines.

The operating company must supplement the operating manual with **operating instructions** based on existing **national regulations for accident prevention** and for the **protection of the environment**, including information regarding supervisory and reporting duties that take account of company-related specifics, e.g. with reference to work organisation, work procedures and the personnel employed.

In addition to the obligatory **regulations for accident prevention and industrial safety** that apply both in the country of use and at the place of use, accepted professional rules for working safely and competently must also be observed.

The operating company must make sure that operating personnel wear **personal protective gear** as appropriate to the local conditions.

**First aid facilities** (first aid kit, etc.) must be kept within reach!

The operating company/user of the machine **must not make any changes, additions or modifications** to the machine that could impair safety without permission from the manufacturer! This also applies to installing and adjusting safety equipment, as well as welding onto load-bearing components.

Any **replacement and wear parts** that are used must correspond to the technical requirements stipulated by **GEDA**. This is ensured with **original replacement parts**.

Only employ **qualified and/or trained personnel** for the tasks described in this manual. The responsibilities of personnel in respect of operating, servicing and repairs must be clearly established! The legally permissible minimum age must be observed!

## 1.7 Intended use

The **GEDA Multilift P12** is a rack and pinion hoist for temporary use on construction sites

- that must only be operated by site personnel who have been instructed and are authorised.
- Determined for the transport of material and persons who can exit the car at installed and secured exit points (landing level safety gates)
- which may only be operated at wind velocities of up to 72 km/h (≈ wind force 7-8 according to the Beaufort scale).
  - at higher wind speeds the car must be parked on the ground and taken out of operation .



**The Multilift can be operated with a base enclosure (Standard) or with a 1.1 m or 2.5 m high enclosure (Comfort).**

Observe and adhere to the data given in Chapter 3.4 “Technical Data”.

Any other use or any use going beyond this is not considered proper use.

**The operating company/user of the machine is solely liable** for any damage resulting from such action. This applies equally to any arbitrary changes to the machine.

### **Intended use includes:**

- That the operation and maintenance provisions (operating manual) provided by the manufacturer are complied with.
- That the foreseeable misconduct of other persons is taken into consideration.
- That the corresponding national regulations are complied with.



**The GEDA Multilift P12 is suitable for temporary use on construction sites. Any other locations or intended uses require written approval from the manufacturer.**

### 1.7.1 Requirements of assembly personnel

The machine may only be assembled, operated and maintained by competent persons who, based on their training, knowledge and practical experience, can guarantee proper handling of the machine and who are aware of the risks associated with the hoist. These persons must be appointed to the tasks of installation, dismantling and maintenance by the operating company.

### 1.7.2 Operating personnel

The machine may be operated only by persons who, based on their training, knowledge and practical experience, can guarantee proper handling.

These persons must

- have been appointed by the operating company,
- have been appropriately instructed and informed about the risks,
- Be acquainted with the operating manual,
- Observe national regulations.
- Damage or faults are to be reported to the operating company immediately.

### 1.7.3 Improper use

- The **GEDA MULTILIFT P12 STANDARD / COMFORT** is not designed for permanent installation.
- The GEDA MULTILIFT P12 must not be assembled to be free-standing (without anchors).
- Persons who have not been instructed about the machine and who are not acquainted with the operating manual, or children, may not operate the **GEDA MULTILIFT P12**.

#### **Consequences of improper use of equipment**

- Danger to life and limb of the user or a third party.
- Damage to the machine and other tangible assets.

## 2 General safety information

The machine has been designed and built according to the latest standards of technology and recognised safety-related rules. Nevertheless, hazards for personnel or third parties and/or damage to machinery and other tangible assets can occur during use, e.g. if the machine:

- Is operated by untrained or uninstructed personnel,
- Is used improperly,
- Is assembled, operated and serviced inappropriately.

Attached notices and warning signs must be observed!

### Consequences of not complying with safety instructions

Non-compliance with safety instructions can result in danger both for personnel as well as for the environment and the machine. Non-compliance can lead to the forfeiture of any damage compensation claims.

### 2.1 Residual risks

There are still residual risks remaining from handling the machinery even when all safety conditions are complied with.

Everyone who works on and with the machine must be aware of these hazards and follow instructions that prevent these residual risks leading to accidents or damage.



#### Caution

- Do not remove safety stickers; replace any safety instructions that have become illegible.
- Hazards when working on the electrical system.
- Danger from improper operation (non-compliance with the operating manual).
- Hazard due to toppling caused by improperly secured load.
- Danger from operating a machine that has not been maintained correctly.

## 2.2 Safety instructions for operating personnel

The operating manual must be within reach at all times **at the location where the machine is used.**

The machine may only be used in a technically fault-free condition, as well as **in accordance with the intended use, in a safety conscious manner aware of the hazards**, and while observing the operating manual! In particular rectify faults immediately that could impair safety!

In addition to this, the machine may only be operated when all **safety features are present and functioning!**

Check the machine **at least once each working day** for externally identifiable damage and defects! Immediately report any changes (including changes to the operating behaviour) to the office/person in charge. If necessary, shutdown and secure the machine immediately! The **responsibilities** for different jobs within the context of operation, servicing and maintenance of the machine must be clearly stipulated and adhered to. This is the only way to avoid mistakes especially in hazardous situations.

The pertinent **rules for prevention of accidents** as well as the other, generally recognised, safety-related and industrial health related rules must be adhered to.

The operator is obliged to wear **personal protective equipment** as appropriate to the local conditions.

**Switch-on and shutdown procedures, including emergency shutdown**, must be observed in accordance with the operating manual for all work that affects operation, and for conversions and adjustments to the machine and its safety features.

## 2.3 Safety instructions for transport

Immediately report **transport damage** and/or **missing parts** to the supplier.

During transport work, wear a **safety helmet, safety shoes** and **safety gloves!**

**Never step under suspended loads!**

Only use **appropriate, standardised and tested lifting gear**, forklifts, cranes) and sling gear (round slings, lifting straps, sling ropes, chains) for transport at the assembly site.

When selecting hoisting equipment, always take into account the **maximum suspended loads!**

Please refer to the dimensions and weights in the technical specifications chapter (3.4).

Only carefully load and transport equipment that has been **disassembled, packaged and lashed.**

Always ensure that the machine is transported **without being knocked or jolted.**

Observe the **pictograms on the packaging.**

Only attach gear to the **designated sling points.**

Always secure transported loads **against falling or tipping over!**

## 2.4 Safety instructions for operation

Only operate the machine, under consideration of the operating manual, **when it is fully serviceable and in a safety and hazard conscious manner.**

If **work is interrupted**, switch off the machine at the **main switch** and secure it with a padlock against switching on.

Fundamentally, the machine must be **secured against unauthorised use** (disconnect from power)!

In situations that present a **risk to the operating personnel** or the machine, shut down the machine by pressing the **EMERGENCY STOP** button.

Shutdown and lower the machine when wind speeds are >72 km/h (45 mph). (Wind force 7-8, wind breaks branches off trees, makes walking very difficult!)

No one is allowed to stand under the machine.  
Do not store any objects under the machine.



### DANGER

#### Danger to life

No structural attachments must be installed **on or over the car** (e.g. roof, covers...).

No one is allowed to stand under the machine.  
Do not store any objects under the machine.

Protection to prevent persons from falling must be provided at loading heights above 2.0 m. (Install landing level safety doors.)

**Persons** being transported must comply with the **instructions given by the car operator**, in particular, they must not step over material that is being transported.



## 2.5 Safety instructions for servicing, maintenance and troubleshooting

**Operating personnel** must be **informed** about how to carry out special work and maintenance work before they start.

**Deadlines** that are stipulated or stated in the operating manual for recurring **tests/inspections** must be adhered to.

The **maintenance area** must be **cordoned off** as extensively as required!

Fundamentally, before any maintenance work on the machine

- Unload,
- Switch off at the master switch.  
(Wait five minutes until the frequency converter has discharged.)

All **servicing and maintenance work is only permitted when the main switch turned off**. Manual intervention while the machine is running can lead to serious injury and is therefore prohibited. If it is necessary to **turn the machine on during** such work, then this must only be done while complying with **special safety measures**.



**For further instructions about maintenance / maintenance intervals / servicing, refer to the maintenance manual.**

If the machine has been completely shut down for these tasks, it must be secured against switching on unintentionally:

- **Operate the Emergency STOP button,**
- **Lock the main switch with a shackle lock and**
- **Attach a warning notice to the switch box (main switch).**

Any faults that could impair safety must be rectified immediately.

**Workshop equipment** that is suitable for the specific work is imperative for carrying out **servicing and maintenance tasks**.

When carrying out maintenance tasks at greater height, a fall-protection device must be worn!

Keep all handles, railings and the car free from dirt and contamination.

When working below the car, it must be secured using appropriate means (activate the setting mechanism).

Before starting servicing/repair tasks **clean** the machine, in particular connections and screw connections, from oil, operating fluids, contamination and maintenance products. Abrasive cleaning agents must not be used. **Loosened screw connections** during servicing and maintenance tasks must always be **tightened** using the necessary **torques!**

Do not change, remove, bypass or bridge safety devices. If it is necessary to **remove safety devices** during servicing and repairs, the safety devices must be installed and **checked** immediately after completion of servicing and repair tasks!

Do not make any changes, additions or modifications to the machine. This also applies to the installation and adjustment of safety devices such as limit switches.

Immediately replace damaged or detached notices and warning signs, as well as safety labels.

Ensure that auxiliary supplies, as well as replaced parts, are disposed of safely and in an eco-friendly manner (also refer to Chapter 6)



**The aforementioned safety measures apply equally for work in the context of eliminating faults.**

## 2.6 Safety whilst working on the electrics

If there are faults on the electrical system of the machine, it must be immediately shut down using the main switch and secured with a lock!

Work on the electrical equipment of the machine must only be carried out by **qualified electricians** working in accordance to electrical engineering regulations! Only professional electricians may access the machine's electrics and carry out work on it. **Always keep the switch boxes closed** as soon as they are left unattended.

**Never work on live parts! System parts on which inspection, maintenance or repair work** is to be carried out must be **disconnected from the mains**. Operating fluids that have been disconnected must be secured against being switched back on unintentionally or automatically (lock away fuses, block isolating switches, etc.). The disconnected, electrical components must first be tested to ensure they are voltage-free, then earthed, short-circuited and isolated from neighbouring live components.

If **tasks must be carried out on live components** (only in exceptional circumstances) an **additional person** must be present to operate the **EMERGENCY STOP** button or main switch in the event of an emergency. Only use insulated tools!

Only original fuses with the stipulated amperages may be used! Never repair or bypass defective fuses. Only replace fuses with fuses of the same type.

**Changes to the control program** can impair safe operation. All program changes require the manufacturer's approval.

During repairs, make sure that **design features** are not **modified** so that they have a negative influence on safety. (e.g. creeping distances, clearances and distances must not be made smaller by insulation.)

Fault-free **earthing** of the electrical system must be ensured by a **protective earth system**.

## 2.7 Tests

The **GEDA MULTILIFT P12** is a machine in compliance with the EC machinery directive 2006/42/EC. A copy of the conformity declaration is reproduced in this operating manual.

### Checks after assembly → Assembly instructions

**The following tests have already been carried out at the factory:**

- Dynamic check with 1.25 times the load.
- Electrical tests according to EN 60204
- Function tests.

### Recurring inspections:

(Also refer to the maintenance manual).

Inspections prior to commissioning, recurring inspections and intermediate inspections must be carried out according to national regulations.



**GEDA recommends that you carry out a recurring check on an annual basis. In the case of increased use and strain (e.g. multi-shift operation), carry out inspections at shorter intervals.**

The results of the recurring check can be recorded in writing in the appendix of this maintenance manual.

## 3 Technical description

### 3.1 Description of function

The **GEDA MULTILIFT P12** is a rack and pinion hoist installed vertically for temporary use on construction sites for the transportation of material and a max. of 12 persons.

The car can be entered and exited at secured landing points.

- The base unit can be extended with 1.5 m long mast sections up to a max. installation height of 150 m.
- The machine is equipped with an overload device that switches off travel in both directions when the load capacity is exceeded; a red overload warning lamp lights up on the car control.
- Locked, sliding doors are located on the cage. The enclosure door, landing level door and car door must be opened individually to enter the car. A car door can only be opened if the car is standing in front of the corresponding enclosure or landing level door.
- Complete assembly of the construction hoist includes the safety equipment for the loading and unloading points (landing level safety doors).
- Each stop position above has a landing level safety door with manually operated sliding doors and double access doors which are locked. The landing level safety doors can only be opened when the car is stationary at this stop position.
- The car can only be started when the enclosure door, all landing level doors and the car doors are closed.
- The construction hoist is switched on at the key switch at the ground control.
- Contact with the ground station is possible through the intercom in the car.

### 3.1.1 Multilift P12 STANDARD

The hoist is equipped with a 1.1m high base enclosure.

The control can be operated from the car, the ground station or the landing levels.

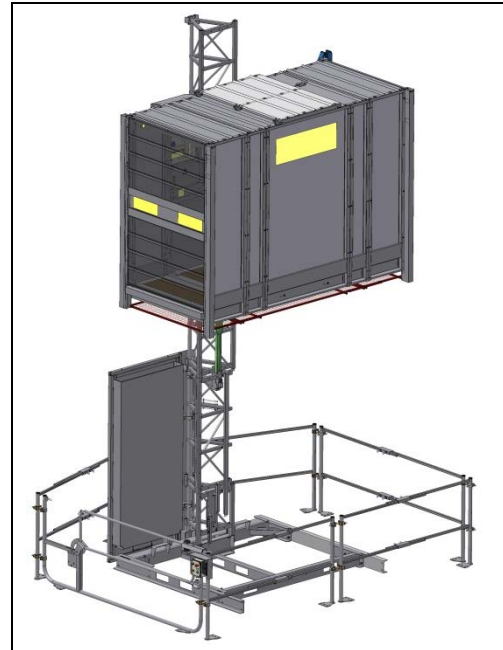

#### **Exceptions:**

During assembly, only the car control is active. All other control points are switched off, only the EMERGENCY STOP push-buttons remain functioning.

During operation, the control at the upper levels can only be operated above the safety height of approx. 2 m. Downwards travel using this control unit is only possible down to 2.0 m above ground level.

Travel within the safety range can only be carried out from the car or ground control unit. Since there is only a medium-high enclosure, an approx. 3 sec. warning signal is emitted before starting when in this range. An underrun protection is installed beneath the car which stops the car if it comes into contact with obstacles on the descent.

The lifting speed in this area is approx. 12m/min.

The **MULTILIFT P12 STANDARD** can be assembled with or without any distance to the wall depending on which sliding door design (with or without ramp) is mounted to the landing level entry side of the car. This car door also dictates which landing level safety equipment (with sliding doors or double doors) have to be used.

### 3.1.2 MULTILIFT P12 COMFORT

The hoist is equipped with a 2.50 m high base enclosure.

The control can be operated from the car, the ground station or the landing levels.

**Exceptions:**

During assembly, only the car control is active. All other control points are switched off, only the EMERGENCY STOP push-buttons remain functioning.

When in operation, unrestricted control is also possible from the control panel on the ground or from the top landing.

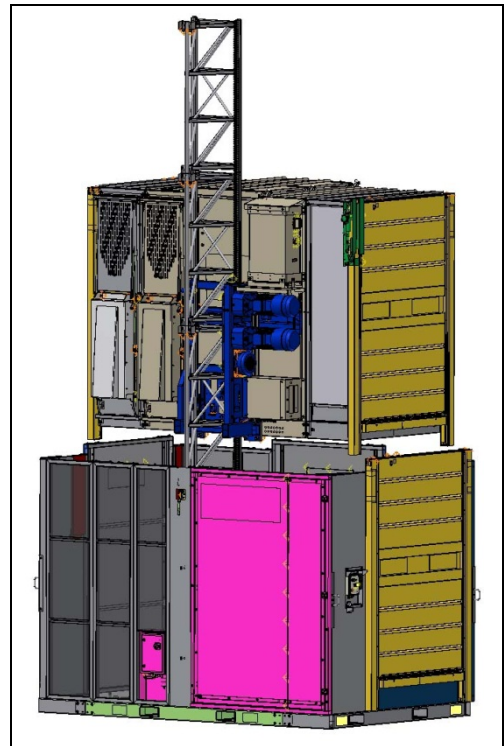

The **MULTILIFT P12 COMFORT** can be assembled with or without any distance to the wall depending on which sliding door design (with or without ramp) is mounted to the landing level entry side of the car. This car door also dictates which landing level safety equipment (with sliding doors or double doors) have to be used.

### 3.2 Machine equipment

#### 3.2.1 GEDA MULTILIFT P12 STANDARD

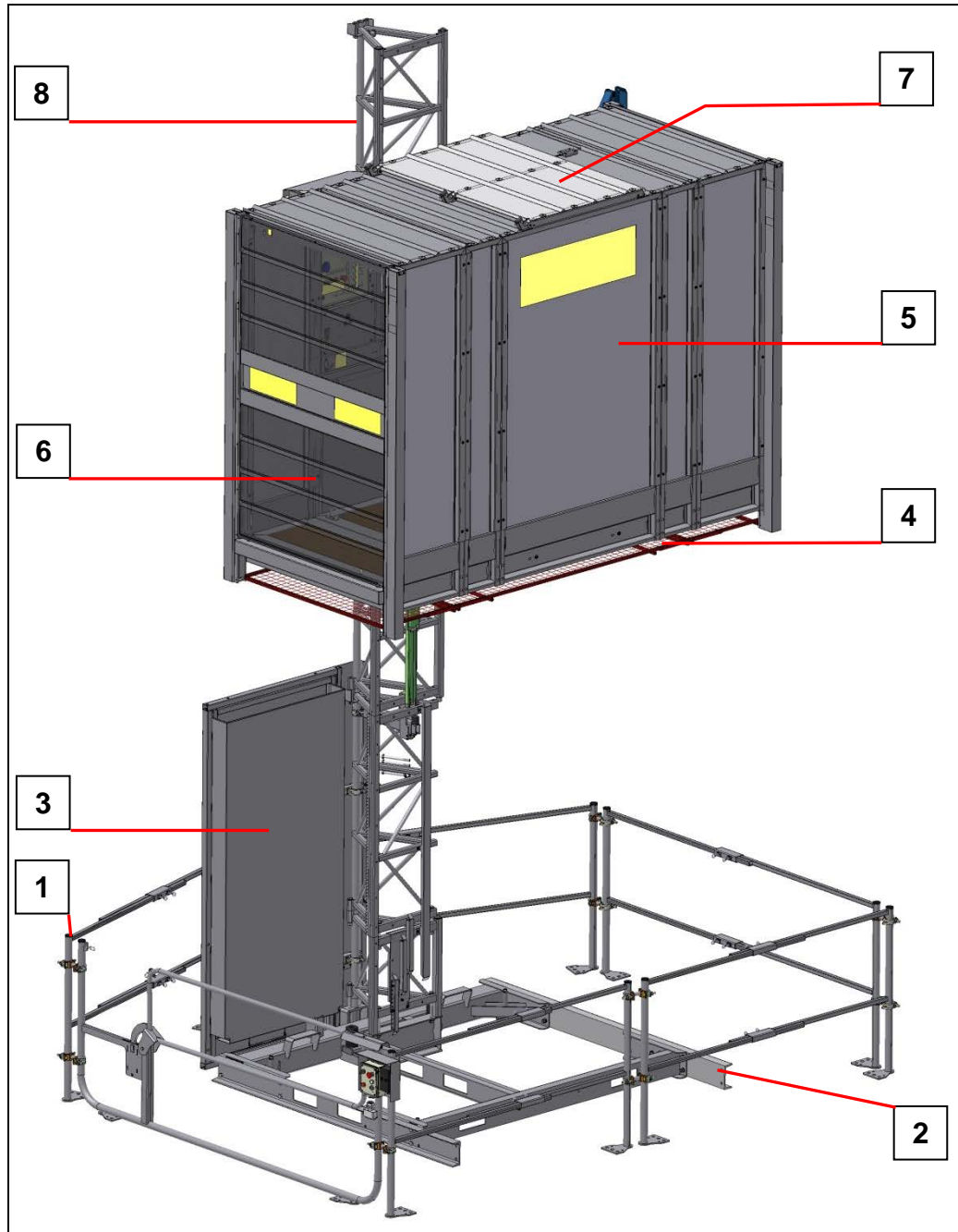

1 = base enclosure 1.1 m with barrier  
 2 = Foot section with base mast  
 3 = Cable box for flat cable  
 4 = underrun protection

5 = Car  
 6 = sliding doors (without ramp)  
 7 = assembly flap  
 8 = Mast extension



3.2.2 GEDA MULTILIFT P12 COMFORT

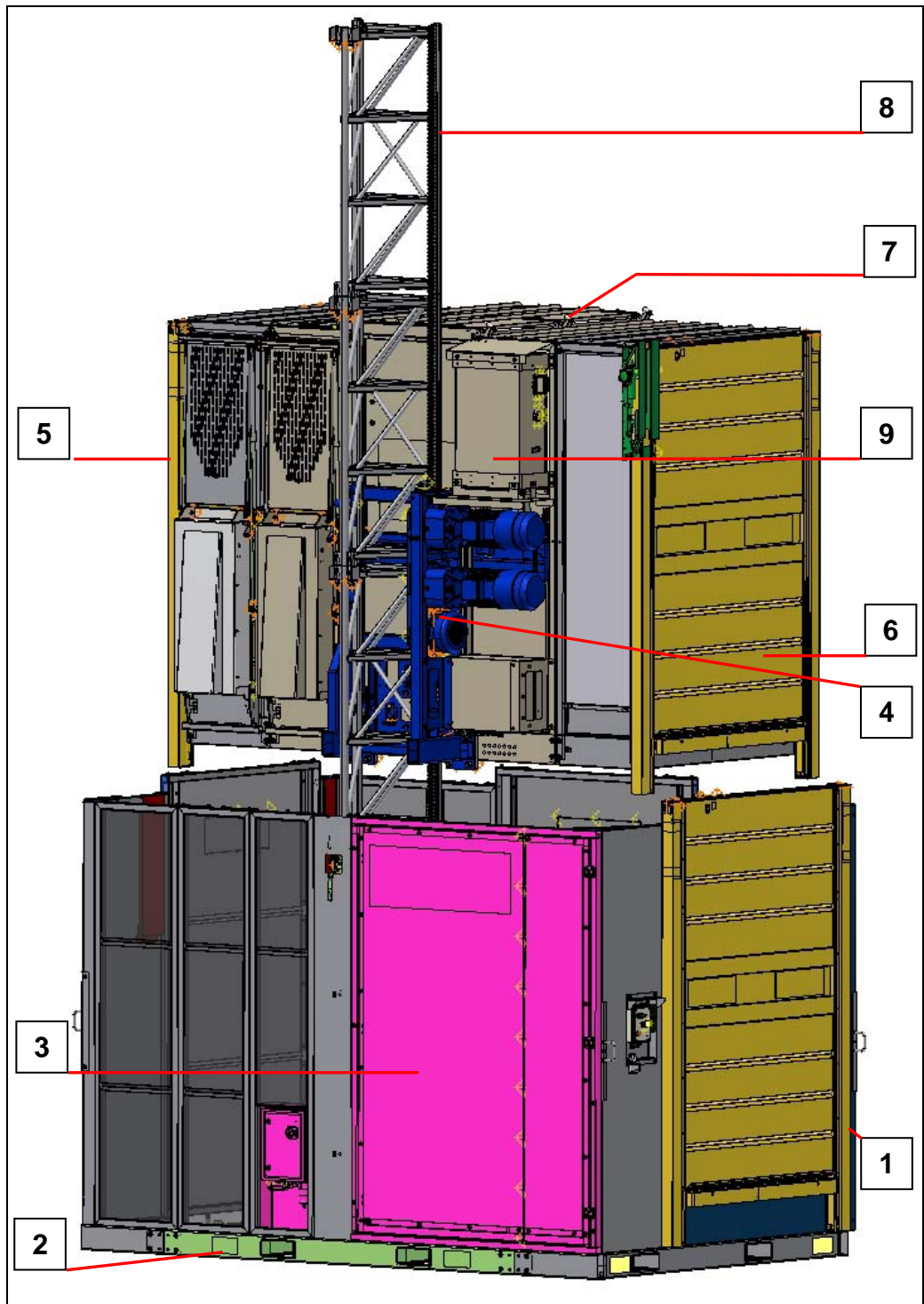

- |  |                         |
|--|-------------------------|
| 1 = base enclosure 2.50 m with sliding doors | 6 = Sliding doors, cage |
| 2 = Foot section with base mast              | 7 = assembly flap       |
| 3 = Cable box for flat cable                 | 8 = Mast extension      |
| 4 = Trolley with drive and safety brake      | 9 = Car control         |
| 5 = Car                                      |                         |

### 3.2.3 Trolley with drives

- 1 = Drive motors
- 2 = Safety gear
- 3 = frequency converter switch box
- 4 = Car control switch box
- 5 = Cable box
- 6 = Automatic lubrication device
- 7 = Trailing cable holder

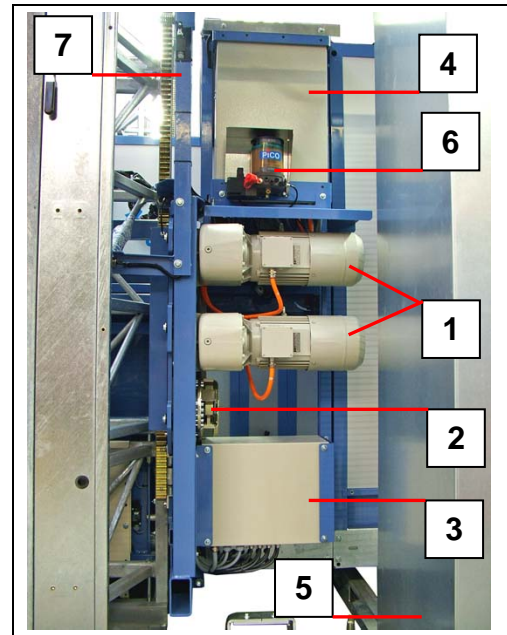

### 3.2.4 Ground-station switch box

- Connect the mains supply line (5) to the mains network (building site main distributor).
- Connect the supply line for ground control to the 16-pole socket (2).
- Connect the supply line for first level control to the 7-pole red socket (3).
- Connect the limit switch line from the setting mechanism to the 4-pole circular socket (4).
- Switch on main switch (1).

1 = Main switch

- 2 = socket (ground control)  
 3 = Socket (red) for landing level equipment (or dummy plug during assembly)  
 4 = Socket for setting mechanism  
 5 = Mains supply line  
 6 = Travelling cable



#### Socket adapter for travelling cable



**The tie-ins equipment must only be connected into the trolley switch box after the rubber multicore cable has been replaced.**

- Install the travelling-cable guide bracket to the trolley and plug the travelling cable into the trolley switch box (also refer to the assembly instructions).



### 3.2.5 Control at the ground station

- 1 = **EMERGENCY STOP** button
- 2 = **UP** button (ascend to uppermost level)
- 3 = **DOWN** button  
(descend to ground station)
- 4 = **Landing stop button**  
(car stops at the next level)
- 5 = Key switch, construction hoist **ON/OFF**
- 6 = Control light, ready for service  
(illuminates when the key switch (5) is  
switched on)
- 7 = Voice module

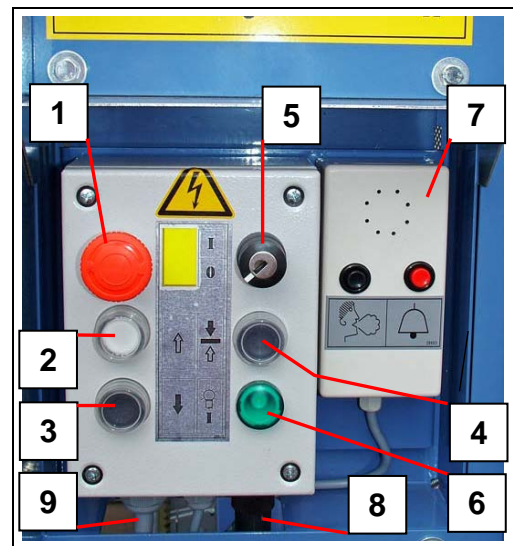

- 8 = Socket [black / 7-pole] for monitoring the enclosure sliding door
- 9 = Supply line with plug [16-pole] to the ground-station switch box.



***On the MULTILIFT P12 STANDARD the UP button (2) and the DOWN button (3) must be pressed below the 2 m safety height.***

### 3.2.6 Control at the levels

On the **MULTILIFT P12 STANDARD** the car can only be moved above the initial 2 m safety height with the “**UP**” (2) or “**DOWN**” (3) buttons.

On the **MULTILIFT P12 COMFORT** the car can be moved using the level control down to the ground station.

The car can be stopped at any time using the **EMERGENCY STOP** button (1).

- 1 = **EMERGENCY STOP** button (does not engage)
- 2 = **UP** button
- 3 = **DOWN** button
- 4 = **Landing stop button** (car stops at the next level)

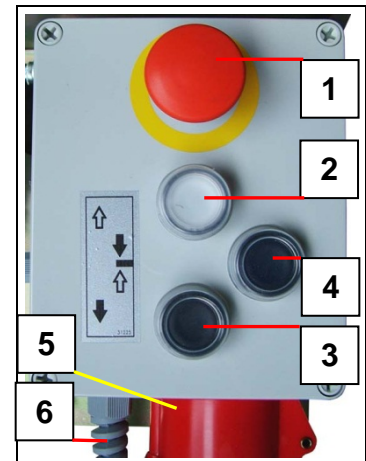

- 5 = Socket [red / 7-pole] for the next higher landing control (or dummy plug at the top landing control)
- 6 = Supply line with plug [7-pole] for the next lower landing control.



**The dummy plug is always removed from the cable box switch box and plugged into the uppermost level control.**

### 3.2.7 Car control

- 1 = **EMERGENCY STOP** button
- 2 = Key switch
  - Position left = Assembly  
(only the car control is active)
  - Position right = Operation  
(car control, ground control and landing controls are active)
- 3 = Control light, ready for service
  - Continuous light  
Hoist ready for service
  - Slow flashing light  
Deficiency of grease in the lubrication device
  - fast flashing light  
Overtemperature motor or overtemperature brake resistor
- 4 = Control light, overload

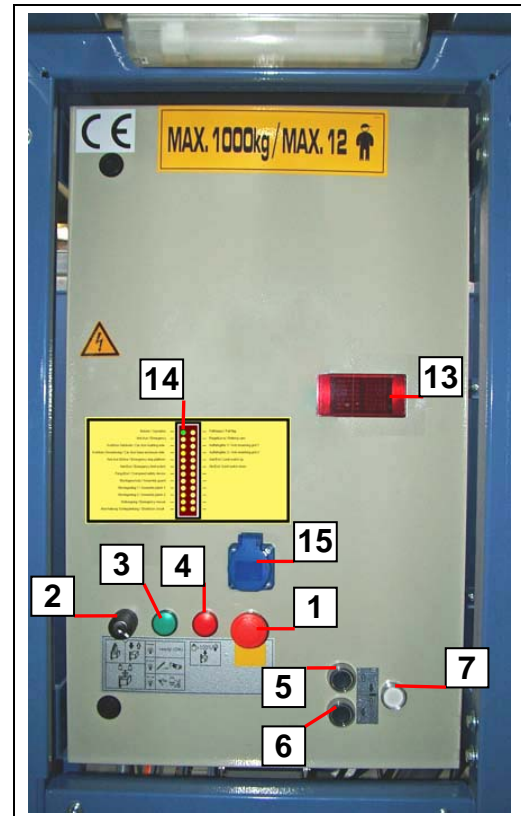

- 5 = **UP** button
- 6 = **DOWN** button
- 7 = **Landing stop button**  
Car stops at the next landing / **Reset button** for hoists with frequency converter
- 13 = Indication of direction of travel and landing stop of the actual landing
- 14 = Diagnostic system display (option)
- 15 = Working socket 230V/50Hz



### 3.2.8 Emergency call system

The emergency intercom system consists of a voice module at the ground control and at the car control.

If persons are locked in the car, they can contact ground personnel using the intercom system.

The intercom system establishes contact with the ground station.



**The intercom system uses mains power when the base unit is connected to the power supply; an internal battery provides power for operation if there is a power failure.**

As operating elements, for each voice module there is a **CALL** button (red) and a **SPEAK** button (black).

#### To make speech contact

- Press and hold the **RED** call button (1) until the other person answers.
- Press the black **SPEAK** button (2) to speak with the other person (send message).
- After sending the message, release the black **SPEAK** button (2) in order to receive a message from the other person.

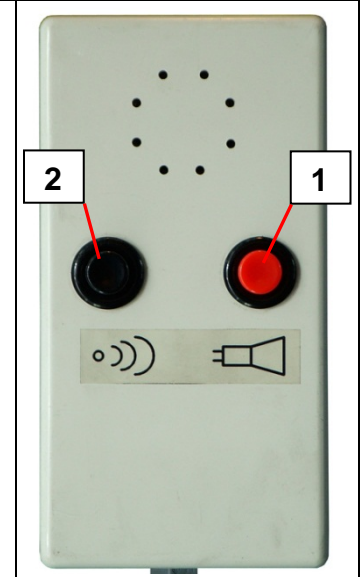
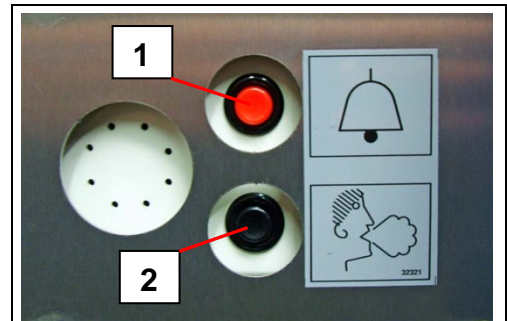

### 3.2.9 Car lighting

- The car lighting (1) is always on as long as the main switch is turned on.

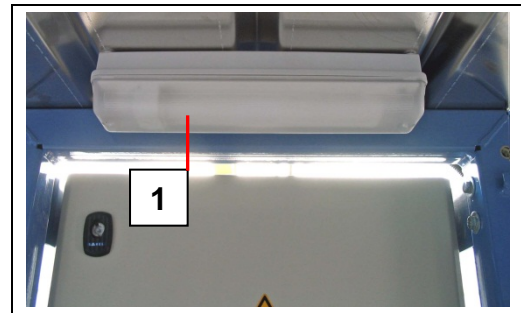

### 3.2.10 Roof hatch

A hatch can be opened in the car ceiling to transport material that is longer than the car (e.g. pipes).

- Remove the bolt (2).
- Swing up the cover (1).

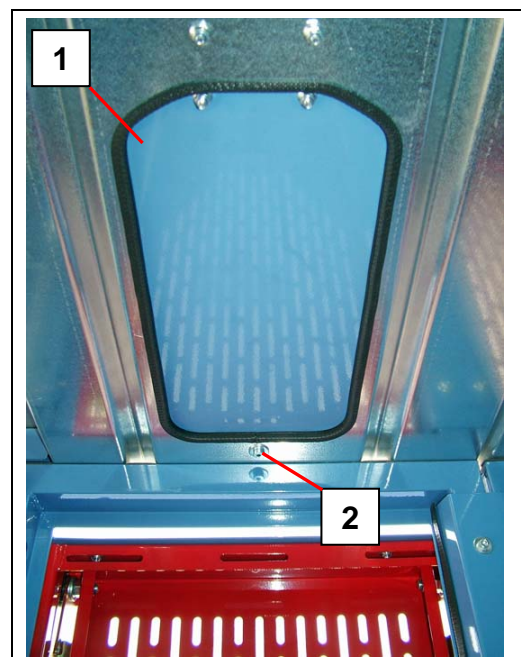

#### CAUTION

##### **Danger of collision**

It is imperative to make sure that material does not protrude into the path of travel.



### 3.2.11 Car / enclosure doors

The sliding doors can only be opened when the car (stopped by the landing level limit switch) stops in front of the landing level equipment or is at the ground station (stopped by the down limit switch). Only the sliding door in front of the access to the base enclosure, or in front of a landing-level safety door, can be opened.

#### Vertical sliding door with counterweight

- 1 = Centre handle grip (1)
- 2 = Lower handle grip (2)

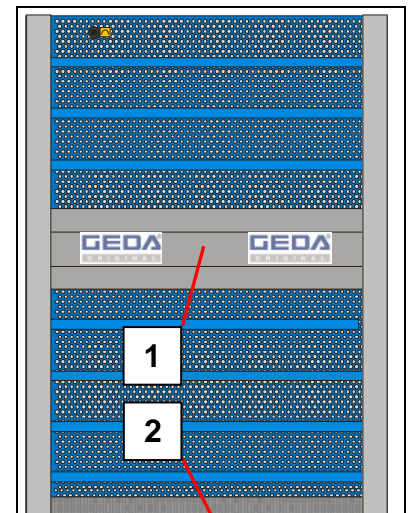

#### Vertical sliding door with ramp

- 3 = Lever to open/close from outside



**The ramp must safely rest on the landing floor and transition plate of the landing level safety door.**

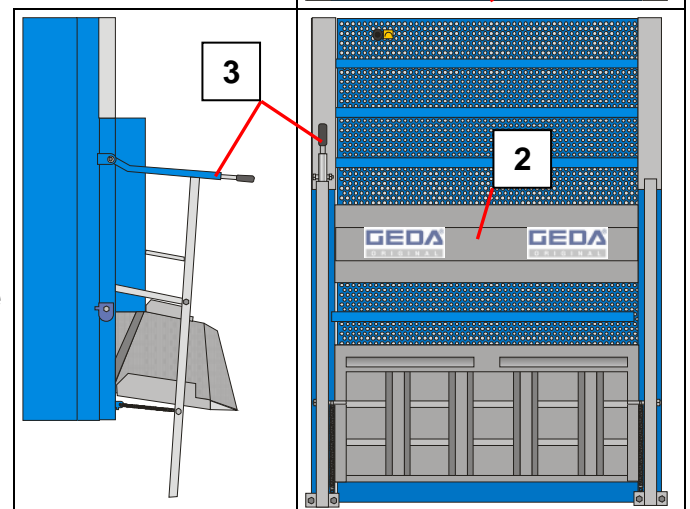

**The lever (3) must be installed on the left or right, depending on the location of the landing level door.**

### Emergency unlocking

Sliding doors of the enclosure and car can only be emergency unlocked from the outside.

- For emergency release, insert the triangular wrench (4) through the hole on the outside of the sliding door.
- Turn to the right (clockwise) until the sliding door can be opened.
- Turn the wrench back after interlock release has been actuated.

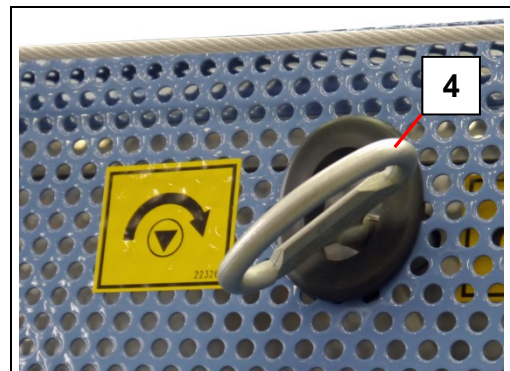

**The triangular wrench is located in the box for the documents and tools.**

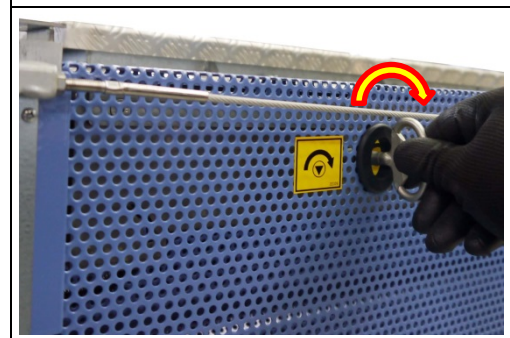

### 3.2.12 Box for documents and tools

The box for the documents and tools contains:

- Triangular wrench to unlock the car and sliding door.

The triangular wrench can also be used to open or close the switch box and emergency interlock release the sliding doors.

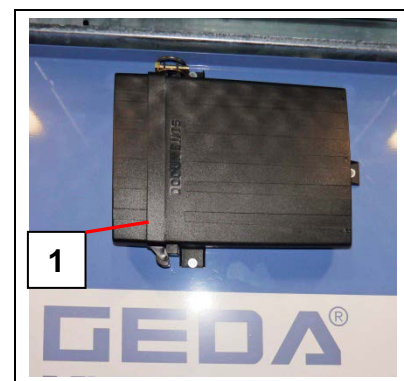

The document and tool box should contain.

- The instruction manual for the machine
- Spare parts lists
- Circuit diagrams
- Operating instructions of the operating company
- Rescue plan of the operating company

### 3.3 Components as accessories

#### 3.3.1 Car control with level pre-selection

The **MULTILIFT P12 COMFORT** model can be equipped with level pre-selection control.

1 = **EMERGENCY STOP** button

2 = Key switch

→ Position left = Assembly  
(only the car control is active)

→ Position right = Operation  
(car control, ground control and landing controls are active)

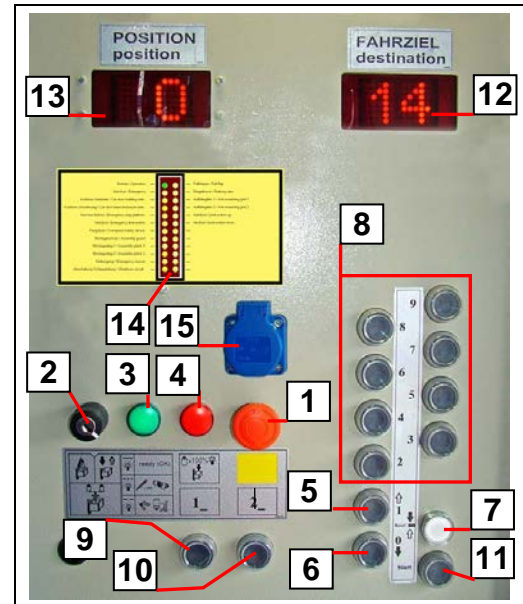

3 = Control light, ready for service

→ Continuous light, hoist is ready for operation

→ Slow flashing light deficiency of grease in lubrication device

→ Rapidly flashing light overtemperature of motor or braking resistance

4 = Control light, overload

5 = Landing pre-selection button for landing 1 [UP button for assembly]

6 = Landing pre-selection button for landing 0 [DOWN button for assembly]

7 = **Landing stop button** car stops at the next landing / **Reset** button for hoists with frequency converter

8 = level pre-selection buttons levels 2 to 9

9 = level pre-selection button from level 10 to 19 (level 10 + level button 1 to 9)

10 = level pre-selection button from level 20 to 29 (level 20 + level button 1 to 9)

11 = start button after level selection

12 = display for level selection

13 = Display of the actual stop position with direction of travel arrow.

14 = Diagnostic system display (option)

15 = Working socket 230V/50Hz

### 3.3.2 Base enclosure 1.10m for the GEDA-MULTILIFT P12 Standard

The four-sided base enclosure consists of five extendable elements (2) [1.39-2.52 m] and one element with barrier (1).

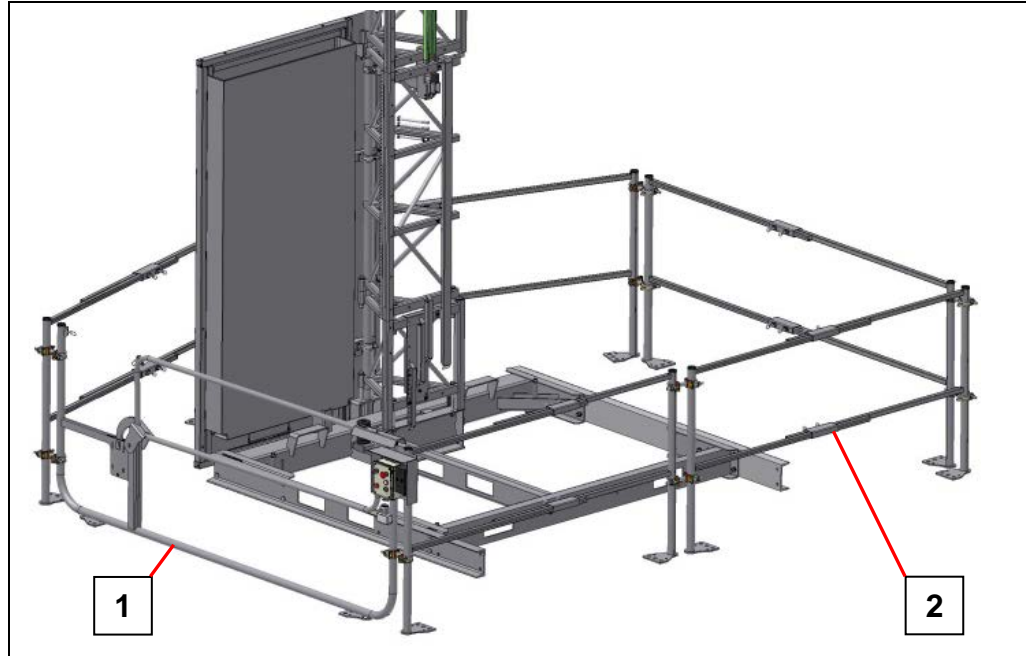

#### Assembly

- The component with the barrier (1) is installed on the access side. The barrier can optionally be installed attached on the left or on the right.
- Position the base enclosure elements (2) around the base unit and bolt together at the ends using scaffolding couplings.

*The length of the base enclosure elements can be adapted to the size of the car.*

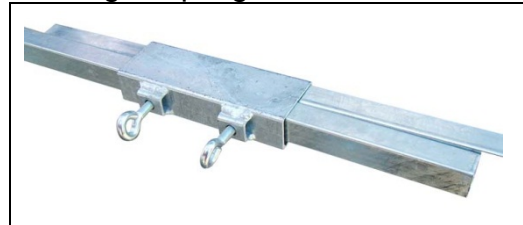

- Mount cabinet (3) for the ground control to the side section of the enclosure using the coupling.
- Hang the ground control with intercom system (4) onto the cabinet (3).
- Plug the supply line (5) (10-pole plug) for the ground control into the ground-station switch box.
- Insert limit switch with retaining plate (6) on the hinge of the barrier.
- Push retaining plate (6) up and tighten with the wing bolt.
- Plug limit switch with retaining plate (6) into the ground control (4).

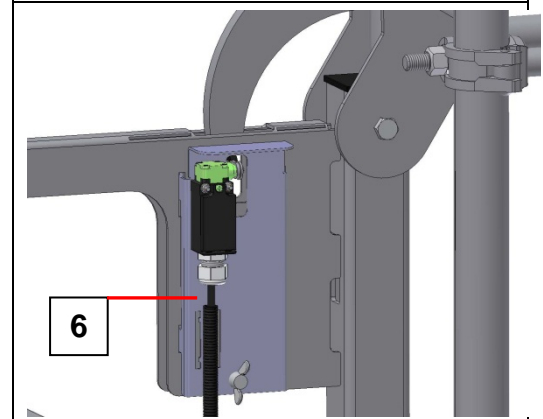
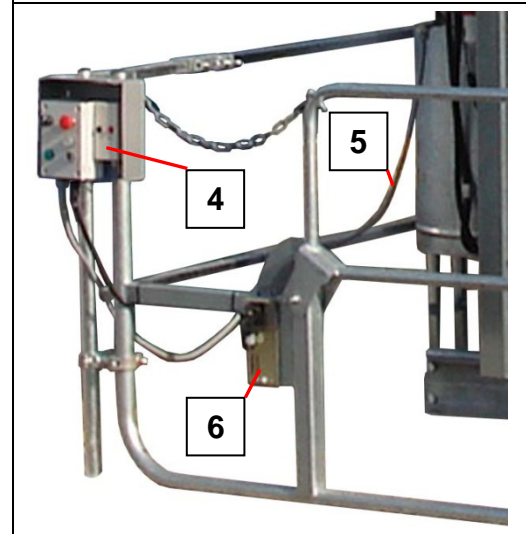
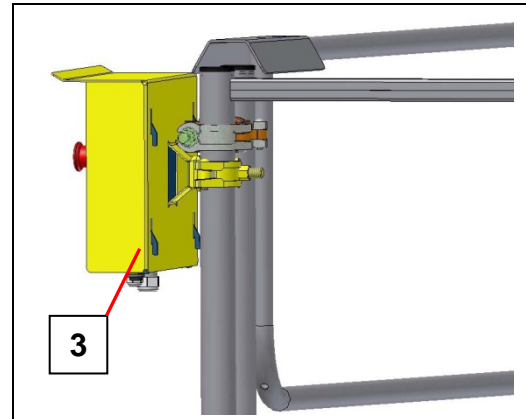



### 3.3.3 Collision grille

Only for **MULTILIFT P12 STANDARD**

If the car collides with obstacles excessive damage to the car, trolley and drive can be caused.

Supplementary protection to the car can be provided by a collision grille (1).



**If the collision grille (1) buckles, the control is interrupted by a limit switch which makes travel impossible.**

### 3.3.4 Mast assembly aid

When assembling the masts, the mast sections, weighing approx. 80kg, can be lifted onto the already mounted mast using the mast assembly aids.

- Remove cover from car strut.
- Attach the mast assembly aid onto the top of the car strut and use bolts to attach it.
- Attach the suspended cross beam to the mast section.
- Wind up the mast section using the manual winch.
- Swivel mast section to the mast and attach.
- Unhook the suspended cross beam and wind it from the mast section.

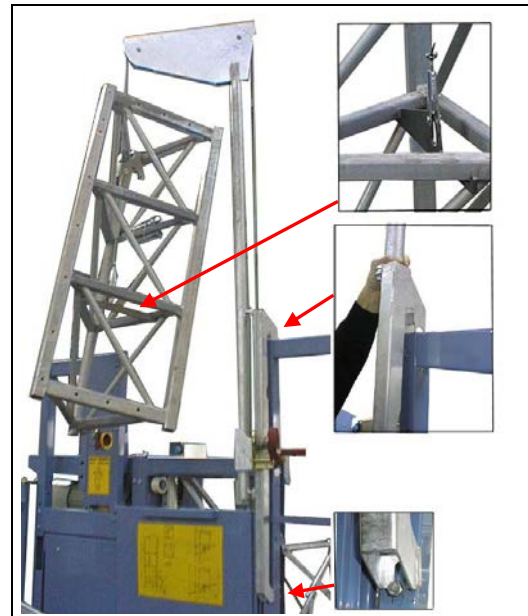

### 3.3.5 Drop test control



The drop test control must not be used during operation or for assembly of the hoist. This control is exclusively for the drop test or “neutral” running when the car is too low.

The drop test control must only be operated by a technically competent person!



## 3.4 Technical Data

### 3.4.1 Operating and environmental conditions

**The machine must only be operated when the following operating and environmental conditions are satisfied:**

Temperature range:	minimum	-20 °C
	maximum	+40 °C
Wind speed:		
Operation/maintenance/servicing	maximum	72 km/h
Installation	maximum	45 km/h

Weather conditions:  
No storms with risk of lightning.

It may be necessary to cease/prohibit operation of the machine under extreme weather conditions, even if the operating and environmental conditions are within the conditions stated. For example, due to extreme frost and storm occurring concurrently. Here, the operating company must provide appropriate regulations.

#### **Atmosphere:**

##### **Transporting persons:**

The atmospheric composition must be appropriate for persons in this area. In particular, reduction in the oxygen concentration as a result of displacement or consumption must be prevented. The legal limit values for pollutant concentrations/aerosols and dust in the workplace must not be exceeded.

##### **Transporting material:**

When transporting material, no concentration of abrasive/corrosive substances and of explosive fine particulate matter must occur. If this cannot be safely excluded, then the corrosion protection and/or the functional reliability of the electrical components must be inspected at regular intervals and, if necessary, replaced. Fine particulate matter must be removed.



### 3.4.2 Speeds

	with two speeds	with frequency converter
<b>Lifting speed</b>		
Operation only for design MULTILIFT P12 STANDARD in the lower safety area (0 - 2 m)	12 m / 24 m	40 m
	12 m	12 m
<b>Safety gear (FV35)</b>		
Trigger speed	max. 48 m/min.	
Gravitational acceleration in the car for <b>EMERGENCY OFF</b>	< 1 g	

### 3.4.3 Electrical connected loads

<b>Base unit</b>		
Operating voltage	400 V / 50 Hz / 3Ph/PE	
Mains fuse	3 × 32 A	
Protection class	IP 54 (NEMA 3)	
<b>Drives</b>	with two speeds	with frequency converter
Capacity	2 × 3.0 / 6.1 kW	2 × 7.5kW
Voltage	400 V / 50 Hz	380 V / 65 Hz
Power consumption	2 × 7.5 / 13.8 A	2 × 16.5 A
Max. starting current:	approx. 95 / 65 A	
Duty cycle (DC):	S3 (60%)	S1 (100%)

### 3.4.4 Assembly height

Vertical assembly max. 150 m

### 3.4.5 Access height (threshold level)

Entry height 0.45 m:  
Entry height with cable carriage 0.97 m

### 3.4.6 Emission

Sound level < 78 L<sub>PA</sub>

### 3.4.7 Vibrations in the car

#### Symbols

$a$  = Effective value of acceleration not evaluated

$a_w$  = Effective value of the frequency-weighted acceleration evaluated in accordance with ISO 2631-1:1997

$a_{wx}$  =  $a_w$  in  $m/s^2$  for the x-direction with frequency weighting  $W_d$

$a_{wy}$  =  $a_w$  in  $m/s^2$  for the y-direction with frequency weighting  $W_d$

$a_{wz}$  =  $a_w$  in  $m/s^2$  for the z-direction with frequency weighting  $W_k$

horizontal direction x

Direction of car door

horizontal direction y

transverse to the x-direction

vertical direction z

Direction of travel

Operating status	frequency-weighted vibration acceleration $a_w$		
	$a_{wx}$	$a_{wy}$	$a_{wz}$
Travel upwards / downwards	0.03 -1.1 $m/s^2$	0.03 -1.1 $m/s^2$	0.15 -0.5 $m/s^2$

### 3.4.8 Mast



**Only original GEDA mast sections (Item No. E020300) must be used.**



Length	1.5 m
Weight	82 kg
Rack and pinion module	7 mm
Connecting bolts	4 bolts M 16 × 180 8.8, 2 nuts M 16, 4 washers 17
Tightening torque	150 Nm (width across flats 24 mm)
First mast tie	≤ 6 m
Vertical distance mast ties	≤ 9 m
Vertical distance travelling cable guide	≤ 6 m
Max. protruding mast length:	
Operation	4,5 m
Assembly	9 m

**3.4.9 Data with car “A” (2.0m x 1.4m)**

**Load capacity**

Operation	1500kg /	12 persons
		1420 kg + 1 
		1340 kg + 2 
		1260 kg + 3 
		1180 kg + 4 
		1100 kg + 5 
		1020 kg + 6 
		940 kg + 7 
		860 kg + 8 
		780 kg + 9 
		700 kg + 10 
		620 kg + 11 
		540 kg + 12 
Assembly	600kg	

**Dimensions**

Internal dimensions of the car (width x depth x height)	approx. 1.35 m x 2.0m x 2.19 m (width at assembly guard 1.33 m)
Dimensions, sliding door:	
Clearance, door width	1,36 m
Clearance, door height	2,02 m

**Weights**

	<b>COMFORT</b>	<b>STANDARD</b>
Base unit with car and cable box (30 m flat cable)	2186 kg	1811 kg
with 50 m flat cable	2196 kg	1821 kg
Flat cable per 25 m	+ 12.2 kg	+ 12.2 kg

**3.4.10 Data with car "B" (2.6m x 1.4m)****Load capacity**

Operation	1200kg /	12 persons
		1120 kg + 1 
		1040 kg + 2 
		960 kg + 3 
		880 kg + 4 
		800 kg + 5 
		720 kg + 6 
		640 kg + 7 
		560 kg + 8 
		480 kg + 9 
		400 kg + 10 
		320 kg + 11 
		240 kg + 12 
Assembly	600kg	

**Dimensions**

Internal dimensions of the car  
(width x depth x height) approx. 1.35 m x 2.62m x 2.19  
m  
(width at assembly guard 1.33 m)

Dimensions, sliding door:











Clearance, door width 1,36 m  
Clearance, door height 2,02 m

**Weights**

	<b>COMFORT</b>	<b>STANDARD</b>
Base unit with car and cable box (30 m flat cable)	2378 kg	1926 kg
with 50 m flat cable	2388 kg	1936 kg
Flat cable per 25 m	+ 12.2 kg	+ 12.2 kg

**3.4.11 Data with car “C” (3.2m x 1.4m)**

**Load capacity**

Operation	1000kg /	12 persons
		920 kg + 1 
		840 kg + 2 
		760 kg + 3 
		680 kg + 4 
		600 kg + 5 
		520 kg + 6 
		440 kg + 7 
		360 kg + 8 
		280 kg + 9 
		200 kg + 10 
		120 kg + 11 
		40 kg + 12 
Assembly	600kg	

**Dimensions**

Internal dimensions of the car (width x depth x height)	approx. 1.35 m x 3.2m x 2.19 m (width at assembly guard 1.33 m)
Dimensions, sliding door:	
Clearance, door width	1,36 m
Clearance, door height	2,02 m

**Weights**

	<b>COMFORT</b>	<b>STANDARD</b>
Base unit with car and cable box (30 m flat cable)	2535 kg	2043 kg
with 50 m flat cable	2545 kg	2053 kg
Flat cable per 25 m	+ 12.2 kg	+ 12.2 kg

### 3.4.12 Data with car “D” (3.2m × 1.4m)

**Restrictions**

The **MULTILIFT P12** with car “D”

- is only available in the dimensions 3.2 m × 1.4 m.
- **cannot** be converted to another shape of platform.
- **cannot** be equipped with a sliding door on the C-side.
- **cannot** be equipped with a D-door.

**Load capacity**

Operation	1500kg /	12 persons
		1420 kg + 1 
		1340 kg + 2 
		1260 kg + 3 
		1180 kg + 4 
		1100 kg + 5 
		1020 kg + 6 
		940 kg + 7 
		860 kg + 8 
		780 kg + 9 
		700 kg + 10 
		620 kg + 11 
		540 kg + 12 
Assembly	600kg	

**Dimensions**

Internal dimensions of the car (width × depth × height)	approx. 1.35 m × 3.2m × 2.19 m (width at assembly guard 1.33 m)
Dimensions, sliding door:	
Clearance, door width	1,36 m
Clearance, door height	2,02 m

**Weights**

	<b>COMFORT</b>	<b>STANDARD</b>
Base unit with car and cable box (30 m flat cable)	2335 kg	1843 kg
with 50 m flat cable	2345 kg	1853 kg
Flat cable per 25 m	+ 12.2 kg	+ 12.2 kg

**Assembly bridge**

Load capacity 100 kg

Weight 40 kg

**Mast assembly aid**

Load capacity 100 kg

Weight 27 kg

**Lifting beam**

Load capacity 3000 kg

Weight 30.2 kg



## 4 Operation



The hoist may only be operated by a qualified person appointed by the operating company. This person must be familiar with the operating manual, have sufficient experience and be informed about the risks involved in handling the hoisting equipment.

Operating personnel see Chapter 1.7.2

### 4.1 Safety during operation

- Also observe the safety instructions in Chapter 2.
- Observe the load bearing capacity of the equipment.



		DANGER
	<p><b>Danger to life</b>          Damage to the car.          Engine-powered vehicles (e.g. forklift trucks, lifting working platforms...) must not be transported in the car!</p>	



- The load must be evenly distributed over the car.
- The car must always be loaded in such a way that the access points for loading and unloading and the control point are kept clear.
- Position the load securely. Any material that could slip or fall must be secured.
- A max. of 12 persons can be transported, whereby, the materials transported must be accordingly reduced (refer to Chapter 3.4.9 to 3.4.12).



The machine is equipped with an overload device that switches off travel movement in both directions when the load bearing capacity is exceeded; a red warning lamp illuminates on the car control.

- Protection to prevent persons from falling must be provided at loading heights above 2.0 m. (Install landing level safety doors.)
- Fundamentally, secure the machine against unauthorised use! - When work is finished / during breaks, keep the manual control safe and turn off the main switch and secure with a padlock.
- If the loaded car stops during operation due to a malfunction, the operator must recover the load. - Never leave a loaded car unattended!
- Operation is from outside of the hazard zone or from the car control.
  - Comply with the instructions of the operator.
  - Do not step over material that is being transported as well.

- Operation of the hoist must be stopped if:
  - Temperatures of less than  $-20\text{ }^{\circ}\text{C}$ .
  - there is damage or other malfunctions.
  - If a recurring inspection has been missed (refer to Chapter 2.7).

	 <b>DANGER</b>
	<p><b>Danger to life</b> Do not use the hoist in the case of fire.</p>

	 <b>DANGER</b>
	<p><b>Danger to life</b> Crushing by the car. Never remain inside the enclosure during operation. When working inside the enclosure switch off the main switch and secure against switching on.</p>

	 <b>WARNING</b>
	<p><b>Fall and trip hazard</b> Be aware of steps and objects on the ground when entering / exiting the car.</p>

### ***Special safety instructions for the MULTILIFT P12 STANDARD***

- *Cordon off the danger zone around the hoist.*
  - *Particular care is required near ground level.*
- *Do not stand or work below the car!*
- *No objects may be stored in the cordoned off area or below the car.*
  - *Store material at a safety distance of min. 50 cm from moving parts of the car.*

## 4.2 Commissioning

- Turn the main switch (on the ground-station switch box) to the position "I" [ON].
- At the ground control, set the key switch to position 1.
- On the car control, set the key switch (6) to **Operation**.



**The sliding doors of the car and base enclosure must be closed.**

### 4.2.1 Safety check before starting work

Carry out a test run with an **empty** car and check

- that the complete path of travel is free.
- the door interlocks correctly function (refer to Chapter 4.3.2 to 4.3.4)

#### **Only on the MULTILIFT P12 STANDARD**

- *the wait limit switch and horn function.*

*During descent, the car must stop above the 2m safety height and a warning signal will sound for approx. 3 seconds. Travel to the ground is only possible, from the ground or car control, after the warning signal and again activating the **DOWN** button. Ascent using the landing control is only possible above the 2m safety height.*

#### **The car must be immediately stopped if**

- an EMERGENCY STOP button is pressed.
- the upper limit switch approach bar has been actuated or the trolley has reached the mast end.
- the DOWN limit switch is actuated.

#### **The car must not start if**

- The key switch on the car control is switched off.
- a sliding door on the car is open.
- the enclosure door is open.
- a landing-level safety door is open
- An **EMERGENCY STOP** button is pressed.

#### **Only on the MULTILIFT P12 STANDARD**

#### **The car must not automatically travel further if**

- the car is in the lower (approx. 2 m) safety area.

## 4.3 Operating the car accesses

### 4.3.1 Barrier of the base enclosure (MULTILIFT P12 STANDARD)

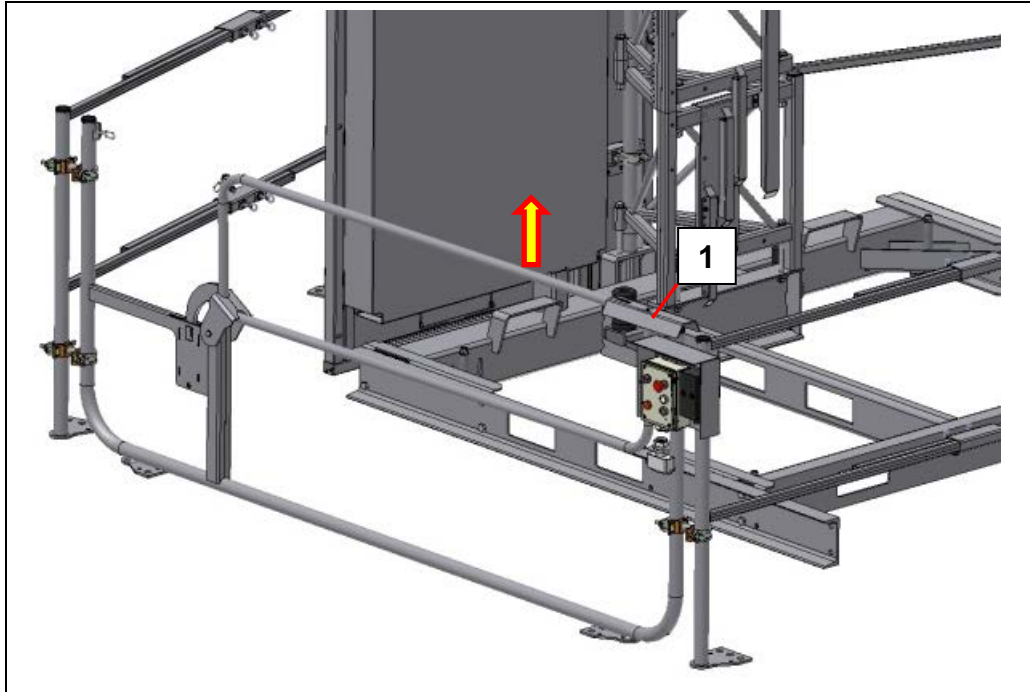

#### **Open**

- Raise the barrier (1) up.

#### **Close**

- Lower the barrier (1) until it lies on the enclosure posts.

### 4.3.2 Sliding doors at the ground station and car

- ☞ It must only be possible to open the sliding door of the base enclosure and car when the car is located at the ground station or in front of a landing level safety door.

#### Vertical sliding door with counterweight

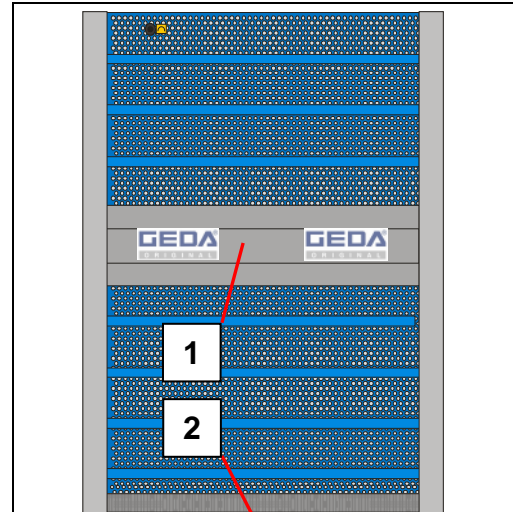

#### Open

- Using the centre handle grip (1) push up the sliding door to the stop.



#### Close

- Using the lower handle grip (2) pull down the sliding door until it is completely closed.

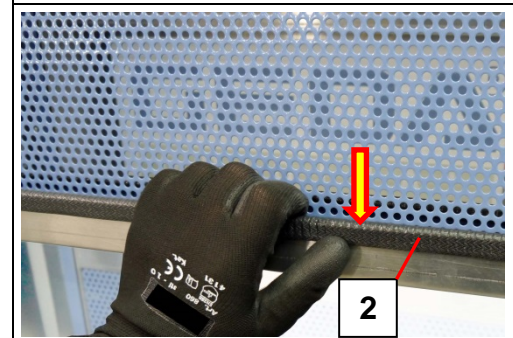

### Vertical sliding door with ramp

#### Opening/closing from the inside:

- Use the handles (2) to carefully open and close the door.

Ramp automatically rises/lowers.

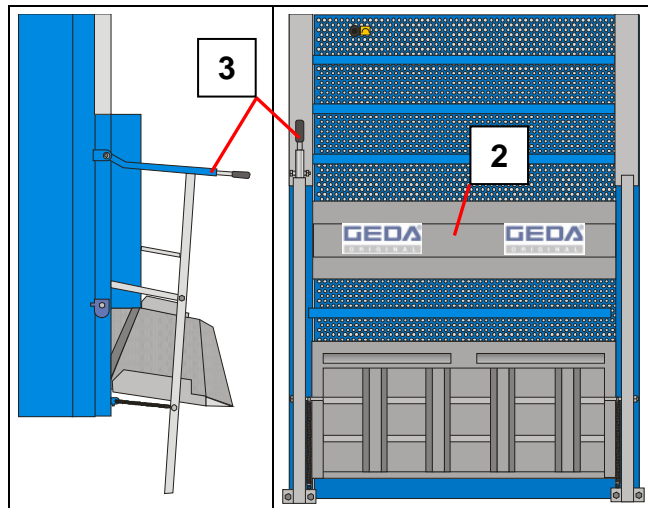

#### Opening/closing from the outside:

- Use the lever (3) to open or close.

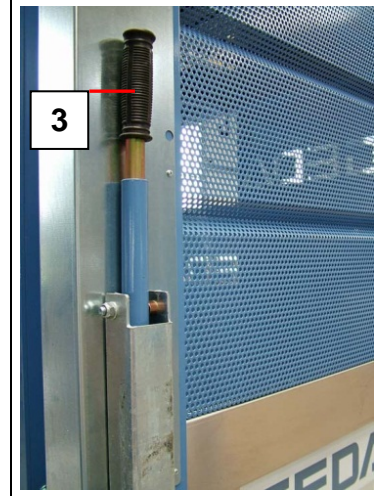

#### Check

The ramp must safely rest on the landing floor and transition plate of the landing level safety door.

## Option for the sliding door with ramp

The sliding door with ramp on the car can be supplied with an electric drive.

The electrically-operated sliding door can be operated from the car and from the landing.

Both locations of control can be individually active or switched off.

### Internal control of the sliding door

1 = Internal control **ON / OFF**

#### Open

- Press and hold the button (2) until the sliding door is open.

#### Close

- Press and hold the button until the sliding door is closed.

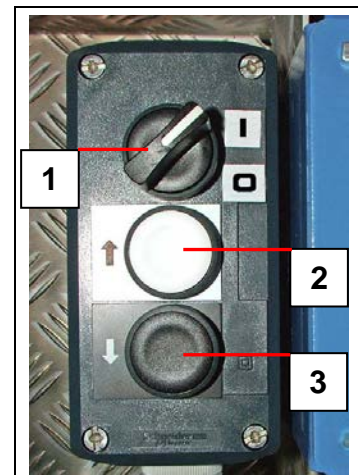

### External control of the sliding door

1 = External control **ON / OFF**

#### Open

- Press and hold the button (2) until the sliding door is open.

#### Close

- Press and hold the button (3) until the sliding door is closed.

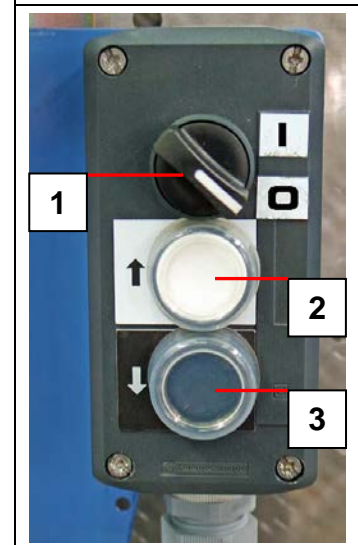



### 4.3.3 Landing level safety door for sliding door with ramp

-  **Sliding, landing level safety doors must only be opened after the loading ramp has been fully folded down.**

#### Open

- Press the lever (1) in the direction of the arrow and push open the sliding door (2).

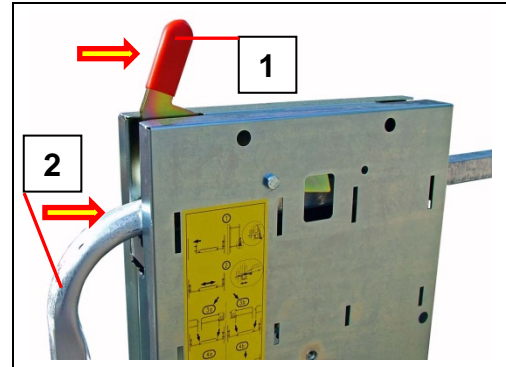

#### Close

- Close the sliding door (2), until the lever (1) engages downwards.

### 4.3.4 Landing level safety door for sliding door with counterweight

-  **The double doors at the stop positions can only be opened when the car is stationary at this stop position.**

#### Open.

- To open, forcefully pull on both handles (2) or, from the car, push on both leaves of the door (1) towards the building / plant.

#### Close

- Pull the handles (2) on the leaf of the door (1) towards the car until the lock (3) engages.





## 4.4 Operating the controls

### 4.4.1 Control at the ground station

1 = EMERGENCY STOP button

#### Ascent

➤ Push the **UP** button (2).

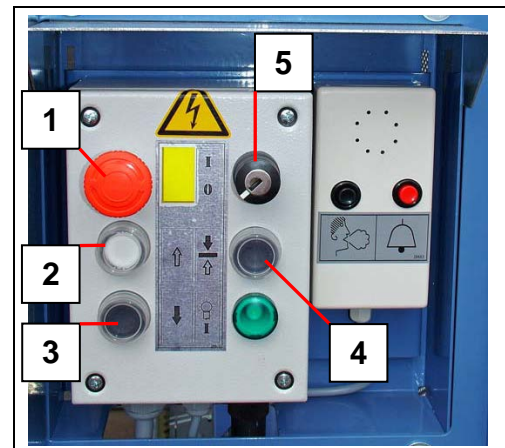

#### **MULTILIFT P12 STANDARD**

Car traverses the lowest 2.0 m off the ground for as long as the UP button (2) is pressed. After passing the 2.0 m safety height, the UP button (2) must be released and the car will move automatically to the top landing level and stop there.

#### **MULTILIFT P12 COMFORT**

The car moves directly to the top level and stops there.

#### Descent

➤ Press and release **DOWN** button (3).

#### **MULTILIFT P12 STANDARD**

The car moves straight down until reaching the approx. 2.0 m safety height. It triggers a warning signal for approx. 3 seconds. During this time the control function is interrupted.

	<b>DANGER</b>
	<p><b>Danger to life</b> Crushing by the car. The operator may only continue the descent after he has ensured that the travel path below is free.</p>

After the warning signal, the remaining 2.0m can only be travelled by again pressing and holding the DOWN button (3) (dead man's control).

#### **MULTILIFT P12 COMFORT**

The car moves from any level down to the ground station.

#### Stopping at landing

➤ Momentarily press the **landing stop** (4) button (4).  
Car stops at the next landing.

#### 4.4.2 Control at the levels

By the **MULTILIFT P12 STANDARD**, the car can only be controlled above the initial 2m safety height using the control at the landings.

1 = EMERGENCY STOP button (does not engage)

##### Ascent

➤ Push the **UP** button (2).  
The car moves directly to the top level and stops there.

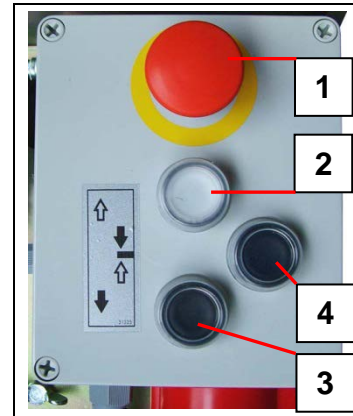

The **MULTILIFT P12 STANDARD** must be moved through the initial 2m safety height using the control at the ground station.

##### Descent

➤ Press and release **DOWN** button (3).

##### **MULTILIFT P12 STANDARD**

The car moves straight down until reaching the approx. 2.0 m safety height. It triggers a warning signal for approx. 3 seconds.

The remaining 2.0m can only be moved using the control at the ground station (dead man's control).

##### **MULTILIFT P12 COMFORT**

The car moves from any level down to the ground station.

##### Stopping at landing

➤ Momentarily press the **landing stop** (4) button (4).  
Car stops at the next landing.

### 4.4.3 Car control

1 = EMERGENCY STOP push-button  
 6 = Key switch  
 (for operation, must be switched to the right)

#### Ascent

➤ Push the **UP** button (2)

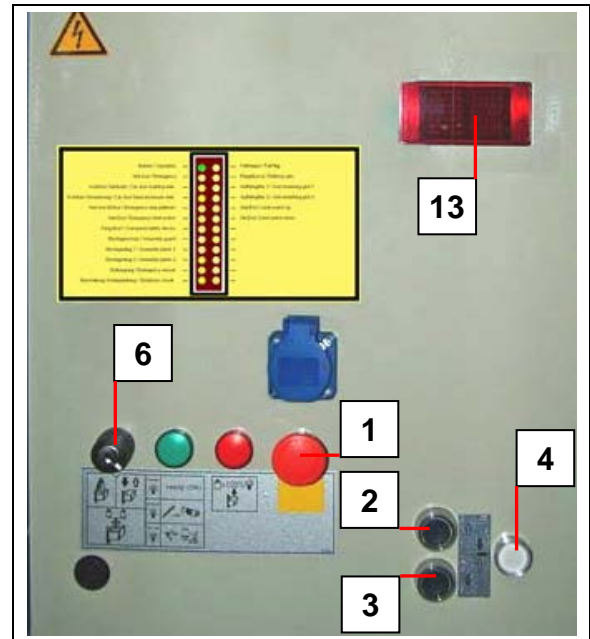

#### **MULTILIFT P12 STANDARD**

Car moves to the lowest 2.0 m off the ground for as long as the **UP** button (2) is pressed. After passing the 2.0 m safety height, the **UP** button (2) must be released and the car automatically moves to the top landing and stops there.

#### **MULTILIFT P12 COMFORT**

Press and release the **UP** button.  
 The car moves automatically to the highest level and stops there.





The landing indicator (13) indicates the direction of travel and, when stopped at the landing, the actual position

**Descent**

- Press and release the **DOWN** button (3).

**MULTILIFT P12 STANDARD**

The car moves down and stops automatically approx. 2 m above the ground. It triggers a warning signal for approx. 3 seconds. During this time the control function is interrupted.

		<b>DANGER</b>
	<b>Danger to life</b> Crushing by the car. The operator may only continue the descent after he has ensured that the travel path below is free.	

*Press the DOWN button (3) again and hold pressed; after the warning signal, the car moves down to the ground and is stopped automatically by the limit switch.*

**MULTILIFT P12 COMFORT**

The car moves down to the ground and is automatically stopped by the **DOWN** limit switch on the base unit.

**Stopping at landing**

- Momentarily press the landing stop button (4).  
Car stops at the next landing.

#### 4.4.4 Car control with level pre-selection [option]

Car control with landing pre-selection can only be ordered for the **MULTILIFT P12 COMFORT**.

1 = EMERGENCY STOP push-button

##### For landings 1 to 9

- Preselect the stop position required for landing 1 to 9 (2 / 8) by briefly pressing a **direct button**.
- Press the **Start button** (11).
  - Car moves to the selected landing and stops there.

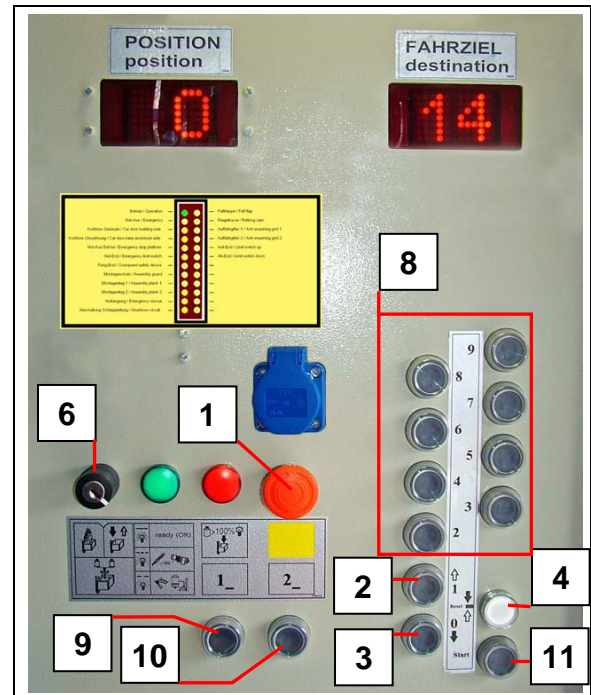

##### For landings 10 to 19

- Preselect the stop position required by pressing the button for landing 10 to 19 (9) and the **direct button** for landing 1 to 9 (2 / 8).
- Press the **Start button** (11).
  - Car moves to the selected landing and stops there.

##### For landings 20 to 29

- Preselect the stop position required by pressing the button for landing 20 to 29 (10) and the direct button for landing 1 to 9 (2 / 8).
- Press the **Start button** (11).
  - Car moves to the selected landing and stops there.

##### For the ground station

- Preselect the ground station by pressing the destination button for level 0 (3).
- Press the **Start button** (11).
  - The car moves to the ground station and stops there.

## 4.5 Emergency shutdown

By pushing an **EMERGENCY STOP** button, the car can be shutdown in situations that present a risk for service personnel or to the hoist.

An **EMERGENCY STOP** button (1) is located on the control at the ground station and on the car control.

 **EMERGENCY STOP** slam buttons (1) are equipped with a latching mechanism and remain active until they are manually unlocked again (turn red button to the right and pull it out).

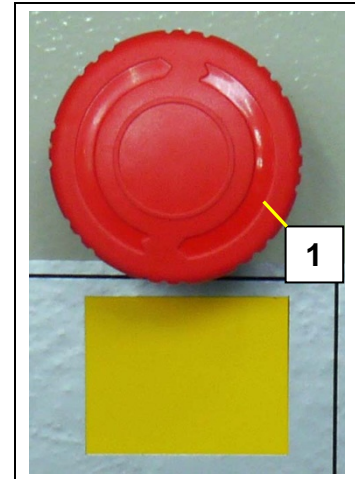

A **stop** button (3) is located on the electric modules of the landing level safety doors and is used to stop travel from each landing. This stop button (3) does not engage which means that further travel is immediately possible after the stop command.

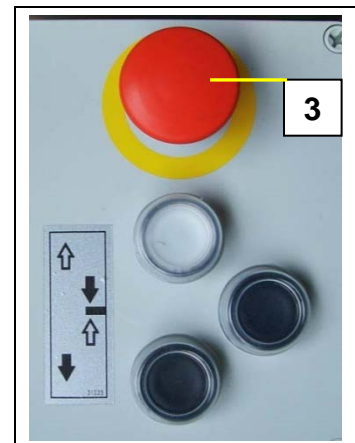

A key switch (2) is located on the control at the ground station, with which the car can be switched off. The car is ready for travel again after being switched on.



## 4.6 Interrupting work – end of work

- Move the car to the ground station and unload.



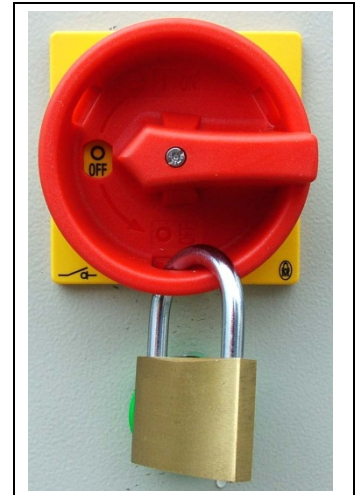

**If there is a risk of frost, move the car up a little, so that the down limit switch is clear.**

- Turn off key switch on the control at the ground station and remove the key.
- Turn off the main switch (Position “0” [OFF]) and secure with a padlock.
- Disconnect the mains plug.



## 5 Malfunctions - Diagnosis – Repair

	<b>WARNING</b>
	<p>Only have troubleshooting and fault elimination carried out by authorised personnel trained especially for this kind of work. Before troubleshooting each time, if possible, move the car down and unload!</p> <p>Immediately discontinue operation if faults occur that endanger operational safety!</p>

 	<b>DANGER</b>
	<p><b>Electric shock</b></p> <p>Before working on the electrical installation of the construction hoist, switch off and lock the main switch. For safety, disconnect the mains plug.</p> <p>Prior to opening the car control switch box, the travelling cable plug must be unplugged!</p>

	<b>DANGER</b>
	<p><b>Danger to life</b></p> <p>Falling during troubleshooting/fault rectification at great heights.</p> <p>Troubleshooting/fault rectification is partially carried out at great heights. In order to reduce the hazard of life-threatening falls: Wear a safety harness at heights of more than 1.80 m.</p> <p>Never use parts of the construction hoist or mast as a climbing aid. Only use tested and sufficiently stable climbing aids.</p> <p>Never climb hands-free. Always hold on with at least one hand.</p> <p>Keep all climbing aids and railings clear of soiling and dirt.</p>



## 5.1 Diagnostic system (Option)

The diagnostic system (1) provides quicker and easier identification of the switching status of the limit switch. After input of the travel command, only the green diode must illuminate. If this is not the case, the corresponding function or corresponding limit switch must be checked.

### Switching status of the LED

green LED = standard ON  
yellow LED = standard OFF

### Significance of the LED / troubleshooting using the diagnostic system

- 1 = Diagnostic system OK / READY
- 2 = Illuminates if the EMERGENCY STOP line is interrupted. If only this LED illuminates, the EMERGENCY STOP line at the enclosure (access door, setting mechanism) or at one of the landing level safety doors is interrupted.
- 3 = Illuminates if the car door that faces the building is not locked.
- 4 = Illuminates if the car door that faces the enclosure is not locked.
- 5 = Illuminates if the EMERGENCY STOP in the car is activated.
- 6 = Illuminates when the limit switch TOP or BOTTOM is activated.
- 7 = Illuminates if the limit switch of the safety gear is activated.
- 8 = Illuminates if the limit switch of the assembly guard is activated.
- 9 = Illuminates if the limit switch of assembly bridge 1 is activated.
- 10 = Illuminates if the limit switch of assembly bridge 2 is activated.
- 11 = Illuminates when the safety lock of assembly bridge 1 is opened.
- 12 = Illuminates if there is excessive tensile force at the travelling cable bracket.
- 13 = Illuminates if the mast connection is incorrect (loose or missing bolts).
- 14 = Illuminates if the activation rail of the interlock cam is extended.
- 15 = Illuminates if the limit switch of the collision grille 1 is activated (only Standard design).
- 16 = Illuminates if the limit switch of the collision grille 2 is activated (only Standard design).
- 17 = Illuminates when the UP limit switch is activated.
- 18 = Illuminates when the DOWN limit switch is activated.
- 19 - 22 = Optional allocation
- 23 = Illuminates if the car has moved to the cable carriage.
- 24 = Not allocated

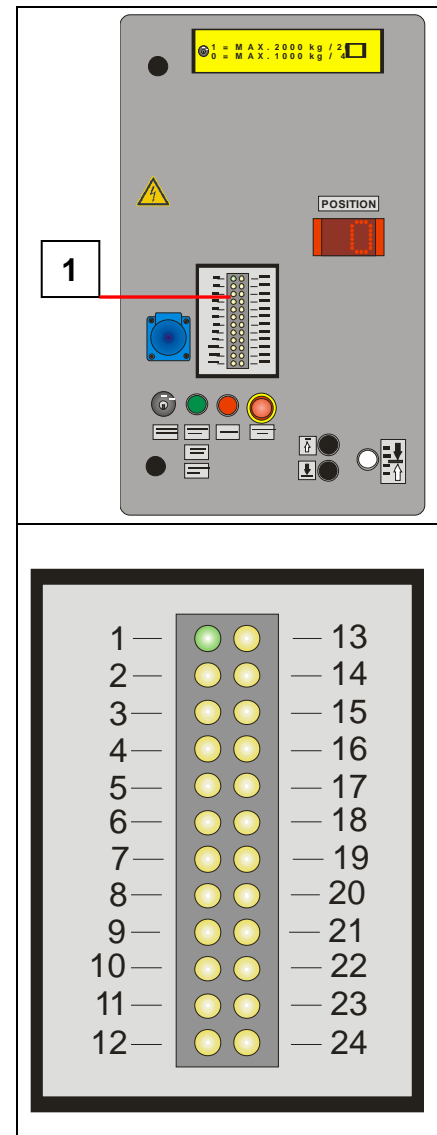

## 5.2 Fault table

Possible faults and the appropriate remedial action are given below.

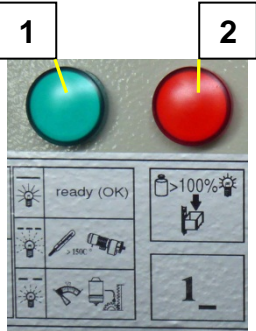
Fault	Cause	Remedial action
<p>Green control light (1) off</p> 	<p>Mains plug disconnected</p> <p>Mains fuses</p> <p>Phase failure</p> <p>Incorrect phase sequence</p> <p>Main switch off</p> <p>Key switch at the ground control set to off</p> <p>Illuminant defective</p> <p>Travelling cable disconnected at the car control</p> <p>Fuses in the switch box ground station okay</p>	<p>Connect mains plug</p> <p>Check mains fuse and replace / switch on if necessary</p> <p>Measurement / correction of the phases</p> <p>Correct the phase sequence at the phase inverter (refer to Chapter 5.3.1)</p> <p>Switch on the main switch</p> <p>Switch on the key switch</p> <p>Replace illuminant</p> <p>Connect the travelling cable below the car control</p> <p>Check/correction</p>
<p>Green control light (1) illuminates Car does not move</p>	<p><b>EMERGENCY STOP</b> button (at a control point) pressed</p> <p>Car door is open</p> <p>Sliding door / barrier at the enclosure is open</p> <p>Landing level safety door open</p> <p>Assembly guard plate open</p> <p>Assembly bridge open</p> <p><b>EMERGENCY limit switch</b> has activated</p> <p>Key switch on the car control switched to incorrect operating mode</p> <p>Safety gear engaged</p>	<p>Unlock the <b>EMERGENCY OFF</b> button</p> <p>Close the car door</p> <p>Close the sliding door / barrier at the enclosure</p> <p>Close landing level safety door</p> <p>Attach assembly guard plate at the top</p> <p>Close the assembly bridge and engage safety hook twice</p> <p>Refer to Car moved too high / too low (Chapter 5.3.5 and 5.3.6)</p> <p>Set key switch to Operation</p> <p>Release safety gear (refer to Chapter 5.3.9)</p>

Fault	Cause	Remedial action
Green control light (1) flashes slowly	Grease container of the lubrication device is empty	Fill the grease container (refer to the maintenance manual)
Green control light (1) flashes quickly	Overtemperature of the drive motors  Overtemperature braking resistances (frequency converter)	Wait until the drive motors have cooled down and unload the car.  Reduce the load Attention! Ascent only possible
Car only moves <b>UP</b>	Is the <b>DOWN</b> limit switch functional?	Check/replace <b>DOWN</b> limit switch
Car only moves <b>DOWN</b>	Is the <b>UP</b> limit switch functional?  Excess distance of proximity switch for monitoring gear rack	Check/replace <b>UP</b> limit switch  Adjust the clearance to the gear rack (3-7 mm)
Red control light (2) (overload) illuminates	Overload protection has triggered	Reduce load until the control light (2) goes off (Refer to Chapter 5.3.3)
Motors do not generate full power	Voltage drop of more than 10%	Select a supply cable or extension cable with a greater cross section (Refer to Chapter 5.3.2)
Car has moved too high (Refer to Chapter 5.3.5)	<b>UP</b> limit switch is defective  Fault in the electrical system	Check/adjust <b>UP</b> limit switch, replace if necessary  Check system
Car has moved too low (Refer to Chapter 5.3.6)	<b>DOWN</b> limit switch is defective  Brake air gap is too large  Car is overloaded  Fault in the electrical system	Check/adjust <b>UP</b> limit switch, replace if necessary  Adjust air gap  Reduce the load  Check system
Door to the base enclosure / car does not open	Car is not exactly at the ground station/landing  Switch / door lock defective	Move car until it is in front of the base enclosure/landing door  Door <b>EMERGENCY</b> unlock. Replace defective lock / switch
Car does not recognise the level selected	Error detecting the landing approach bar  <b>Faulty</b> sensor or distance to the approach bar too large	Use a <b>DOWN</b> button and carry out a reference run to the ground station (refer to Chapter 5.3.8)  Check/adjust <b>sensor</b> and replace if necessary

## 5.3 Fault rectification

### 5.3.1 Phase inverter

The phase sequence (direction of rotation) can be changed at the CEE mains plug using the phase inverter.

- Use a screwdriver and rotate the two contact pins (1) on the phase inverter by 180°.

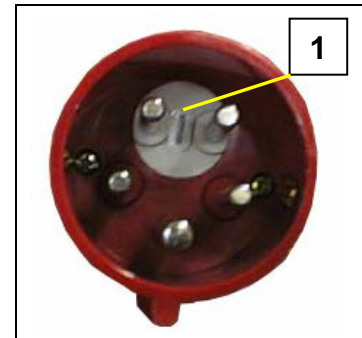

**The MULTILIFT P12 requires a right-rotating field**

### 5.3.2 Motors are not giving full output:

- Voltage drop of more than 10% of the rated voltage.
- Select a supply cable with a greater cross-section.

The integrated thermostiches turn off the control current when overloaded. Work can continue after a certain cool-down period (possibly reduce load).



**Refrain from repeated overheating/overloading. - Otherwise the service life of the motor/brakes will be shortened.**

### 5.3.3 Overload control light is on

The car is equipped with an overload warning device which prevents it being moved if it is overloaded. If the car is overloaded, a red indicator lamp (1) illuminates on the car control.

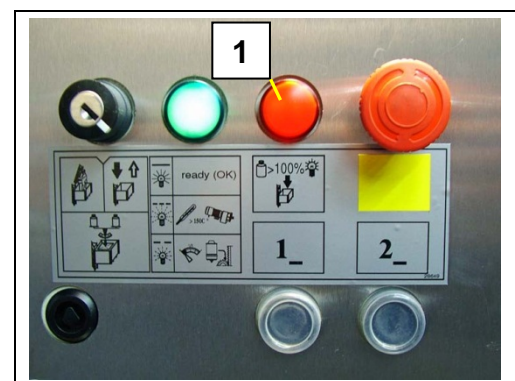

**If the red control light illuminates:**

- Reduce the load in the car until the control light goes off. - Only then is travel possible again.

### 5.3.4 Car door or enclosure door/level door cannot be opened

The car door or enclosure door/level door cannot be opened when the car is not stationary in front of the enclosure door or a level door, or the cage is not supplied with voltage.

#### Possible cause:

- No mains or control voltage.
- Car run too high or too low (refer to Chapter 5.3.5 / 5.3.6)
- The interlock cam (1) of the car does not operate the interlock bolt (2) of the landing level door.
- Defective interlock (3) of a landing level door.

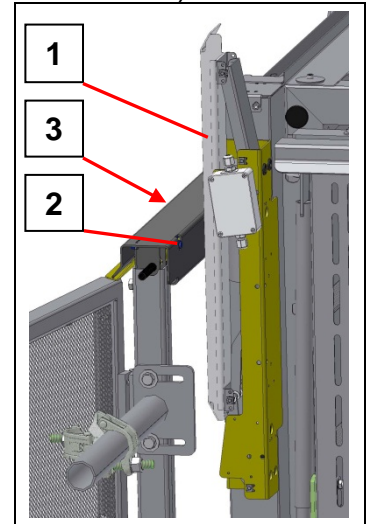

### 5.3.5 Car moved too high

The emergency limit switch for the car can reach the top EMERGENCY limit switch approach bar if

- The level limit switch is defective,
- there is a malfunction in the electrical system.

#### Action:

Activate the motor brake at the manual release lever (refer to Chapter 5.4.2).

### 5.3.6 Car has moved too low

The emergency limit switch for the car can reach the bottom EMERGENCY limit switch approach bar if

- The brake air gap is too large,
- the **DOWN** limit switch at the lowest stop position is defective,
- there is a fault in the electrical system,
- the car is overloaded.

#### Action:

- Connect the drop test control in the car-control switch box (also refer to the maintenance manual).
- From outside the car, push the **UP** button (1). - Now the car will move out of the **EMERGENCY LIMIT** position.

#### CAUTION

The “UP” button (1) must be pressed, because this control bridges the Emergency limit switch. If the red drop-test control buttons are pressed by accident, the motor brake will release and the motor can drop hard onto the foot section (risk of damage).

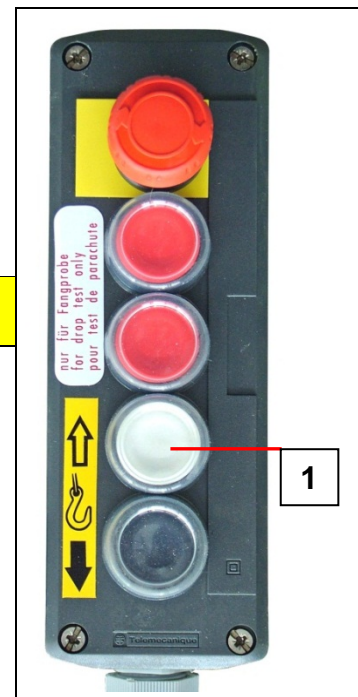

If this effect occurs repeatedly although the car is not overloaded, have the brake checked and adjusted by a qualified person.

### 5.3.7 Frequency converter has switched off

#### Only on machines that are controlled by frequency converter (option)

##### Note regarding reset button

Lift commands are deleted by an open safety circuit (e.g. EMERGENCY STOP button; EMERGENCY STOP button at the level control, etc.). The car will not restart after switching on the **EMERGENCY STOP** button again.

If a travel command is given although the frequency converter is malfunctioning, the car will not start. The travel command remains pending for 10 minutes and can be deleted by pressing the EMERGENCY STOP button.

#### CAUTION

However, if a reset is carried out on the frequency converter whilst a movement command is still pending, the frequency converter will carry out the command and the car will start.

- Remove the cover plate (1) below the switch box for the car control.  
(Allen wrench ● = 8mm)
- Open the switch box behind the cover plate (1).

If the red LED error signal (2) illuminates on the frequency converter, this has switched off and, before continuing operation, must be reset. (Also refer to the manufacturer's operating manual in the documentation.)

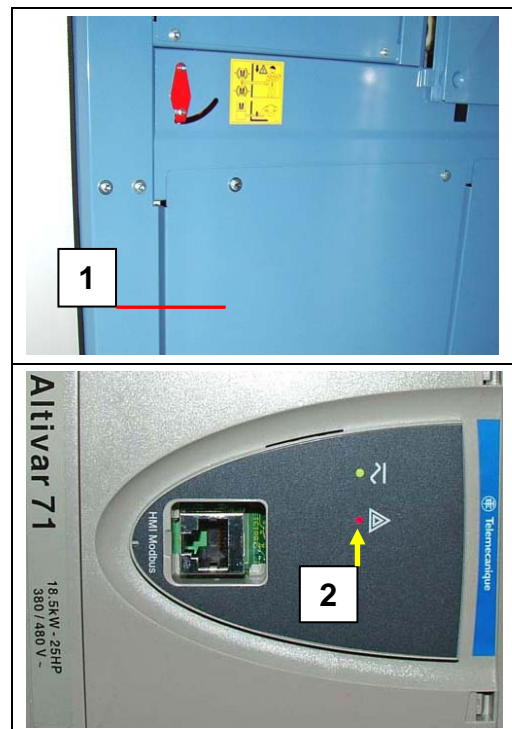

### Reset button for the frequency converter

The button (3) on the car control has a dual function:

→ Level stop button when the car is being operated.

→ Reset button for the frequency converter when the car is stationary.

- Momentarily push the **reset button** (3) to reset the frequency converter. (Red LED error signal (2) goes off)

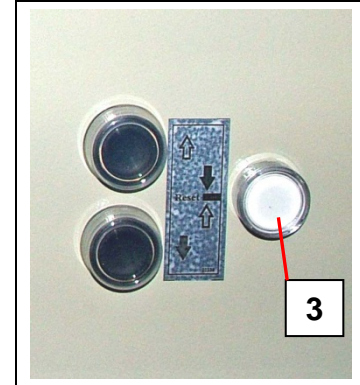

- ☞ The frequency converter can also be reset by switching off the mains supply (approx. 5 minutes).



### 5.3.8 Car does not recognise the level selected

If the car runs past the selected level or stops at the wrong level, then a reference run down to the ground station must be carried out.

- At a control location, press and release the **DOWN** button (1). The car moves down and remains at the (incorrect) level 0.

The remaining travel path to the ground station must be manually controlled.

- At a control location, press and hold the **DOWN** button (1). After approx. 30 sec. the car moves slowly (12 m/min.) down to the ground station and stops at the lowest limit switch.

Now the car can be operated normally again.

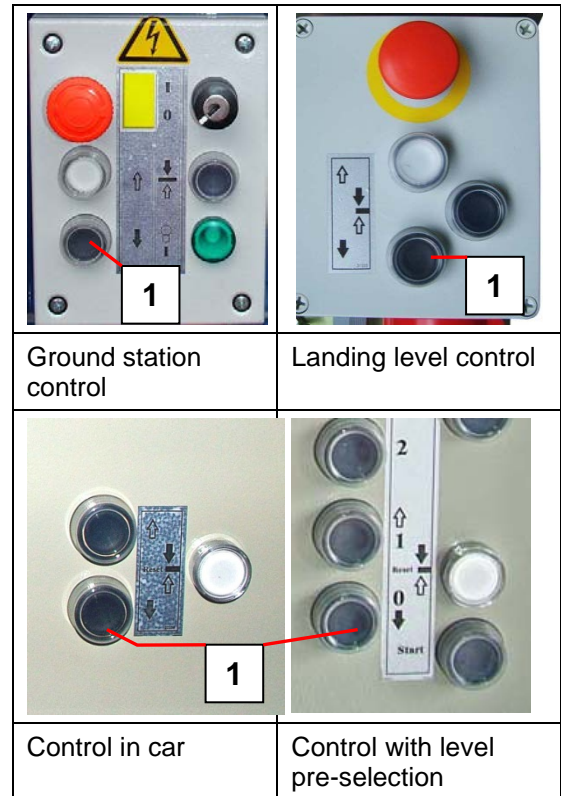

### 5.3.9 Safety gear has triggered

The hoist is equipped with safety gear that brakes if the speed of the car speeds becomes excessive. Further travel is not possible once the safety gear has been triggered.



#### WARNING

##### Danger to life

All persons must exit the car  
Determine why the safety gear has engaged, secure car and repair damage before releasing the safety gear!

The safety gear must only be triggered by a competent person specifically appointed by the operating company who, due to his/her training, knowledge and practical experience, is able to evaluate the risks and assess the safe condition of the safety gear.



**Downward travel is mechanically blocked by the safety gear and may be pressed again only after a brief ascent!**

#### Releasing the safety gear (only by a qualified person)

- Connect the drop test control to the socket in the car-control switch box (also refer to the maintenance manual).
- From outside the danger zone, press the **UP** button on the drop-test control and move up approx. 20-30 cm.

After moving in neutral, connect the blind plug and close the switch box of the car control.

- Remove the cover plate (4) below the switch box for the car control.

(Allen wrench ● = 8mm)

- Release the lock nut (1) on the safety gear.
- Turn the safety-gear protective cover (2) to the left until the limit switch lug (3) engages in the slot of the protective cover (2).
- Re-tighten the lock nut (1).

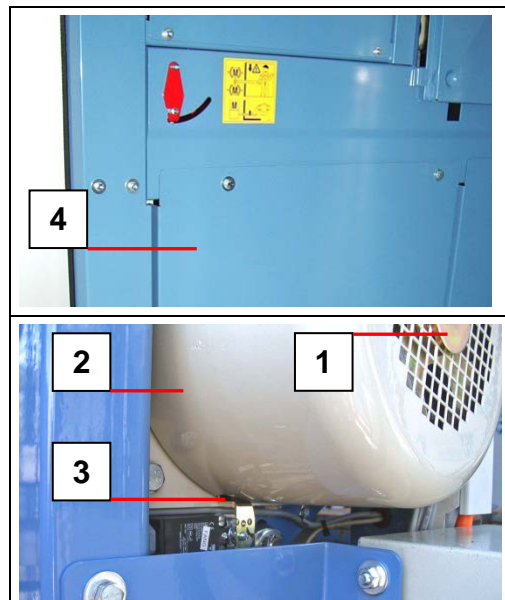

**After the safety gear has activated, it must be checked for signs of damage. The check, carried out by a competent person, is described in the maintenance manual.**

## 5.4 Rescuing people / retrieving the car

Rescue may become necessary in the event that, for example:

- There is a power failure
- The electrical system of the hoist has malfunctioned
- The drives have failed
- The safety gear has triggered

	<b>WARNING</b>
	If the car supervisor does not feel sufficiently qualified to organise and carry out the rescue, the relevant authorities must also be notified. Inform (rescue personnel).

### 5.4.1 Basic conduct in the event of a rescue/malfunction

- Get an overview of the situation!
- Remain calm and do not act hastily!
- Be cautious and thorough when checking the situation!
- Is anybody hurt?
- What led to the unit failing?
- As necessary, press the **Reset** button (refer to Chapter 5.3.7) on the car control to release the frequency converter.
- Using the intercom system, establish contact with the ground station and initiate the check of the mains supply and automatic circuit breakers in the ground-station switch box.
- If this is unsuccessful, then proceed as described in the following section.



**The sequence of measures can / must be varied by the attendant / rescue personnel depending on the specific situation.**

### 5.4.2 Rescuing the car

In an emergency, the next lowest level can be reached by releasing the drive brake. This enables people trapped in the car to evacuate themselves.

	<b>WARNING</b>
	<p>Triggering the safety gear by lowering too quickly. This disables the car which must subsequently be initially raised. Only lower the car very slowly.</p>

- Release the triangular-headed bolt (2).
- Move the cover plate (3) to the side.

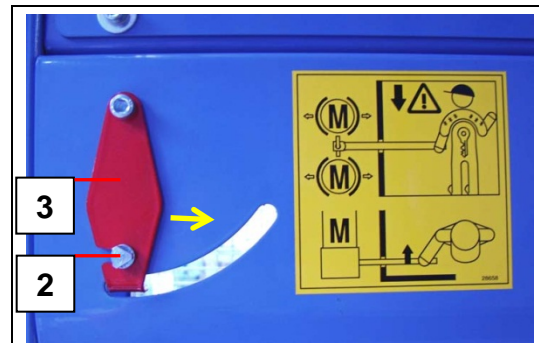

- Remove the lever (1) from the mount (support section of assembly flap).

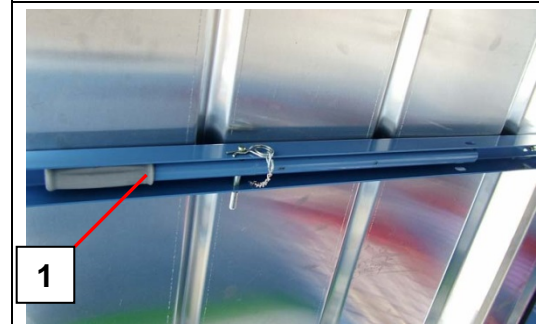

- Push the lever (1) through the opening on the side panelling and guide to connecting rod of the brake release lever.

 **Check the position of the lever through the slot (4).**

- Release the motor brake by carefully metered pulling (towards the centre of the car) on the lever (1).

Car glides down.

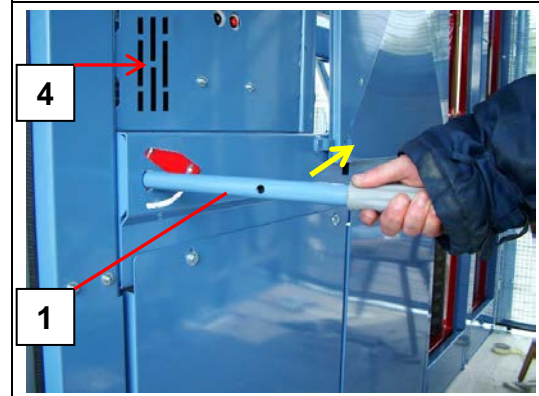

<b>CAUTION</b>
<p>The brake becomes very hot. Interrupt the lowering process for 2 minutes at the latest after every 1-2 meters. The length of a mast section can be used for orientation.</p>

- When at the next landing, release the lever (1).  
Stop the car so that the car and landing door is at the same level.

If the green indicator lamp, the car can be exited as normal.  
Otherwise the doors must be unlocked.

### **Emergency unlocking of the car door**

Refer to Chapter 3.2.11

### **Emergency unlocking of the landing-level safety door with double doors**

The landing level safety door is also equipped with an emergency interlock release for rescue and recovery.

- Remove the triangular wrench (5) from the base-enclosure switch box and insert into the lock of the landing-level safety door.
- Turn the triangular wrench clockwise to the right until the enclosure door opens.

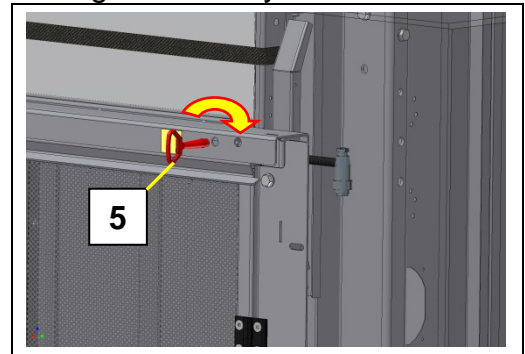

### **After the emergency:**

- Remove the lever (1) and replace in the bracket.
- Install the cover plate using the triangular-headed bolt.

### 5.4.3 Rescuing persons trapped inside

It is not possible to lower the car by releasing the motor brake if, e.g. the safety gear has triggered.

	<p><b>WARNING</b></p> <p>Now check to make sure that no parts of the drive system are broken, damaged or non-operational. In this case, the safety gear must not be released. <b>The hoist must be shut down!</b></p>
---	---

- Establish contact with the ground station via the voice module and discuss how to proceed further.

Evacuation takes place according to a rescue plan.

-  **A rescue plan must be prepared by the operating company and kept in a clearly visible place on the hoist!**



#### 5.4.4 Exit the car over the assembly bridge.

In the event of emergency recovery, the assembly bridge (together with the mast) can be unlocked from outside.

- Turn the safety interlock (1) down anti-clockwise.

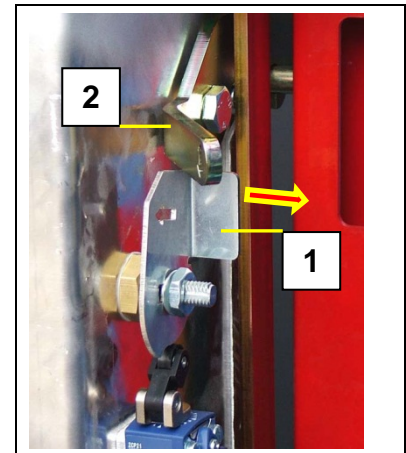

#### Open assembly bridge from the inside.

- With your right hand in the handle grip (3) of the assembly bridge, pull the assembly bridge towards you and open the safety latch (2) with your left hand.
- Slowly push the handle grip (3) outwards and grip the pulling bar (1) with the other hand.

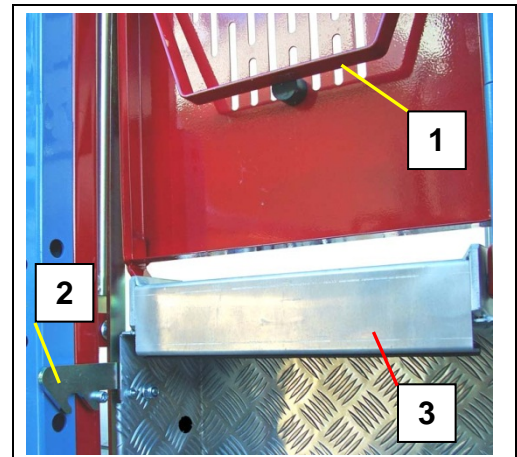

- Release the handle grip (3) and completely lower the bridge using the pulling bar (1).

#### Open assembly bridge from the outside.

The safety latch of the assembly bridge can also be opened from the outside.

- Push the base pan (3) inwards and push the lever (2) on the safety latch down.

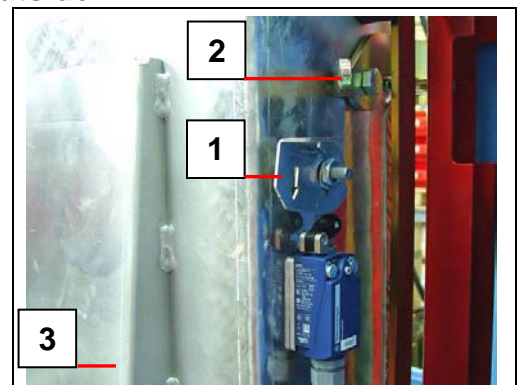

**If the safety interlock (1) is open, the control function is interrupted. After rescue/repair, the assembly bridge must be closed and the safety interlock (1) swivelled up.**

## 5.5 Repair



**Repair tasks must only be carried out by trained and competent persons because they require special expert knowledge and skills. Neither is communicated in this operating manual.**

**When ordering spare parts please provide the following:**

- Type
- Year of manufacture
- Serial No.
- Operating voltage
- Quantity required

The rating plate is located in the car.



**Spare parts must conform to the technical specifications of the manufacturer! Only use original spare parts from GEDA.**

For service or repair work, please contact our customer service department:

**For the sales and customer service address, refer to Chapter 1.4**

## 6 Disposal of the machine

Dismantle the equipment properly at the end of its service life and dispose of according to national provisions.

**Observe the following when disposing of equipment components:**

- Drain and dispose of oil/grease in an eco-friendly way.
- Recycle metal parts.
- Recycle plastic parts.

**Recommendation:**

Contact the manufacturer or commission a specialist company to handle disposal requirements in accordance with regulations.